

CATCHING THE SUGARS: ELECTROCHEMICAL APTASENSORS FOR THE DETECTION OF CANCER-RELATED GLYCOSYLATION CHANGES IN PROSTATE SPECIFIC ANTIGEN

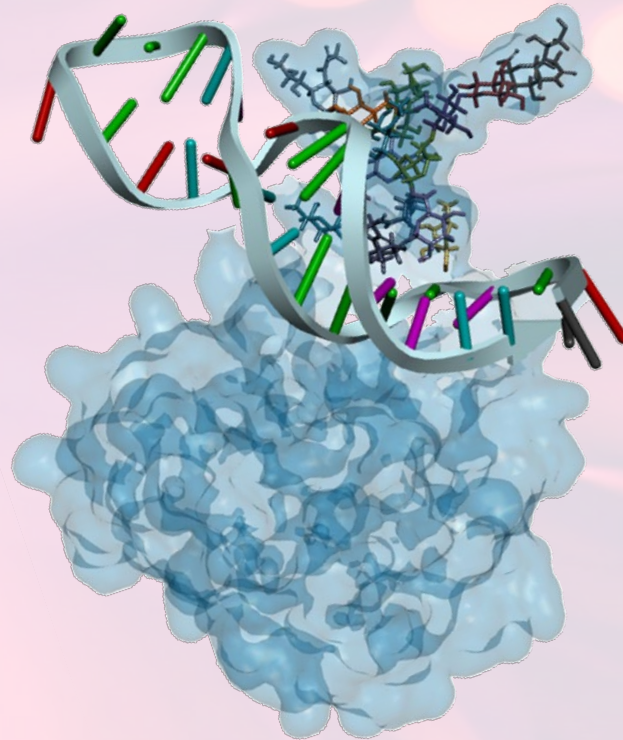

ANA DÍAZ FERNÁNDEZ

R. Miranda-Castro, P. Estrela, N- de-los-Santos-Álvarez, M.J. Lobo-Castañón

PROSTATE CANCER

- Prostate cancer
 - Most common cancer and second cause of death in men
 - It is produced in the tissues of the prostate
 - Detection of prostate cancer:
 - Prostate Specific Antigen (PSA) test
 - Biopsy
- Prostate Specific Antigen (PSA)
 - Biomarker approved for clinical use
 - Increase of PSA level in blood
 - Cut off : 4 ng/mL
 - Not specific, gray zone: 4 – 10 ng/mL

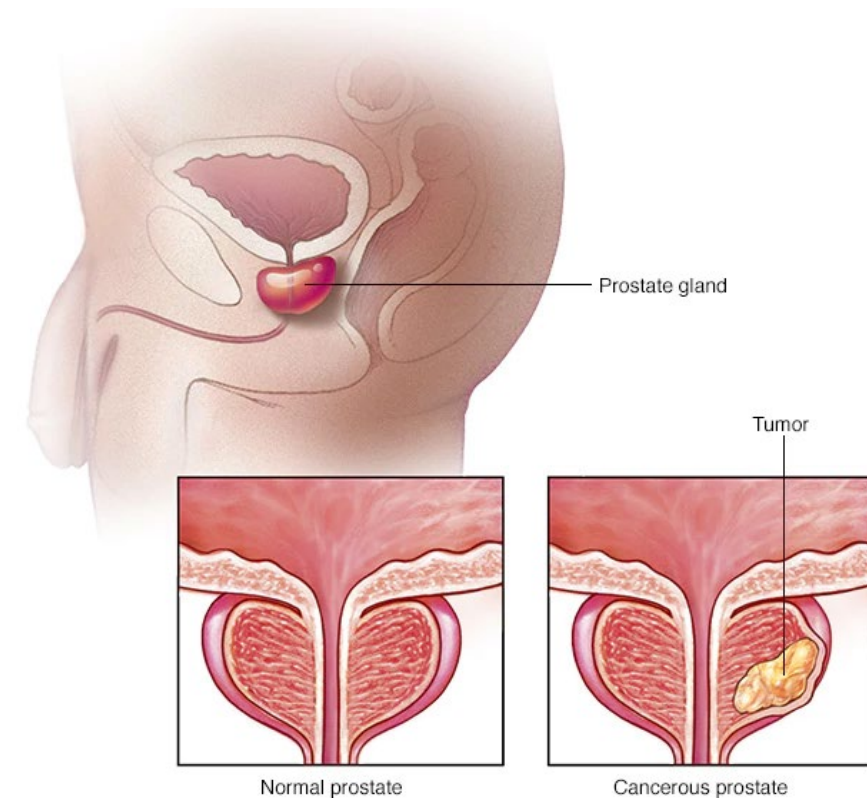

GLYCOSYLATION AND CANCER DETECTION

Glycosylation is different between normal cells () and tumour cells ()

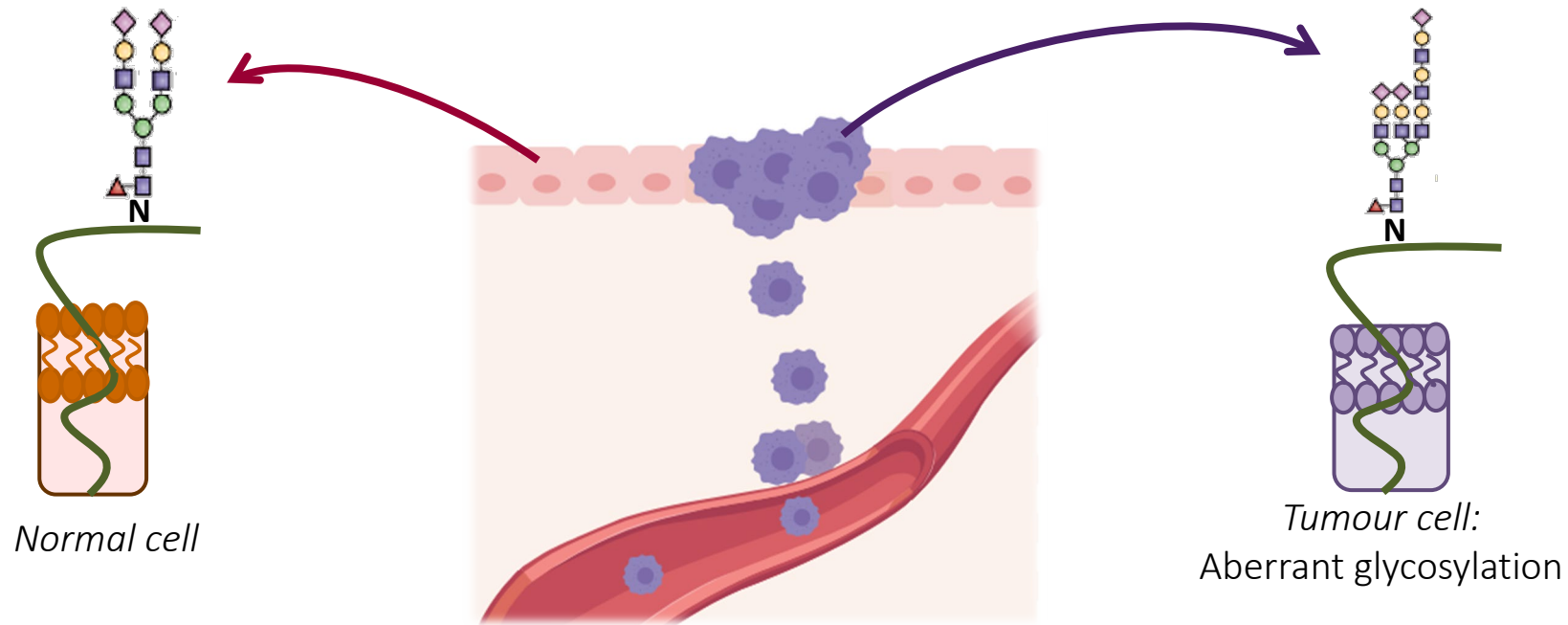

Aberrant glycosylation hallmark of cancer

Exploiting the differences in glycans between cancer and normal cells

PROSTATE SPECIFIC ANTIGEN (PSA)

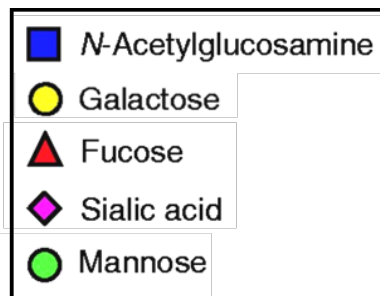
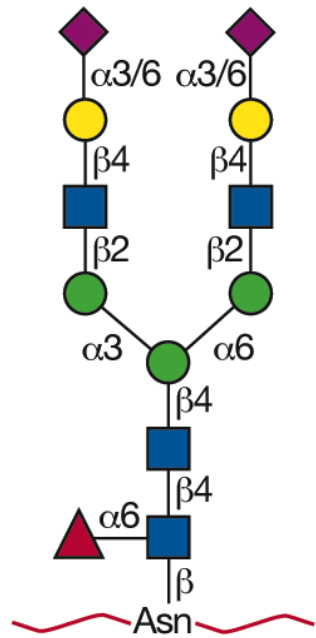

- Glycoprotein from the kallikrein family
- Changes in the glycosylation pattern when there is cancer
 - Increase of sialic acid
 - Increase of core fucose
- Detection of these changes → more reliable diagnosis
- Actual methods:
 - Lectin based assays
 - Proteomics studies

Aptamers can be a good receptor for these glycosylation changes

APTAMERS

APTAMERS: Synthetic receptors

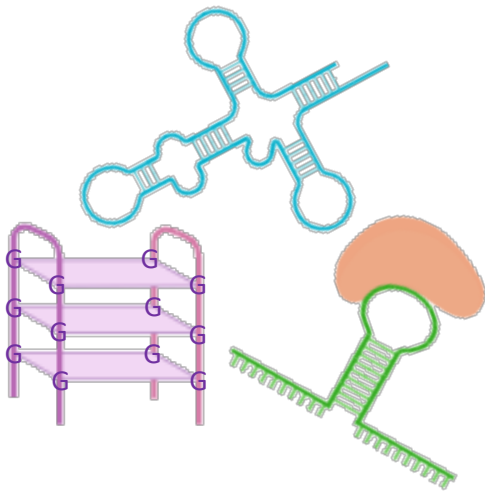

- Single-stranded and short DNA or RNA sequences
- Fold into discrete 3D structures around the target
- Obtained by in-vitro selection known as SELEX
- Known as chemical antibodies

Characteristics

- Chemical synthesis- reproducible and of moderate cost
- Chemical and thermal stability
- Reversible folding to a functional stage
- Easily modified for immobilization or labeling

OBJECTIVES

Development of electrochemical sensors for detecting glycoproteins identified as cancer biomarkers, using as synthetic receptors aptamers specifically recognising the glycosylation site of such proteins as synthetic receptors.

1. Are aptamers already described able to recognise the glycans in PSA?
2. How to select new aptamers specifically recognising the glycosylation site of PSA?

BINDING OF ANTI-PSA APTAMER

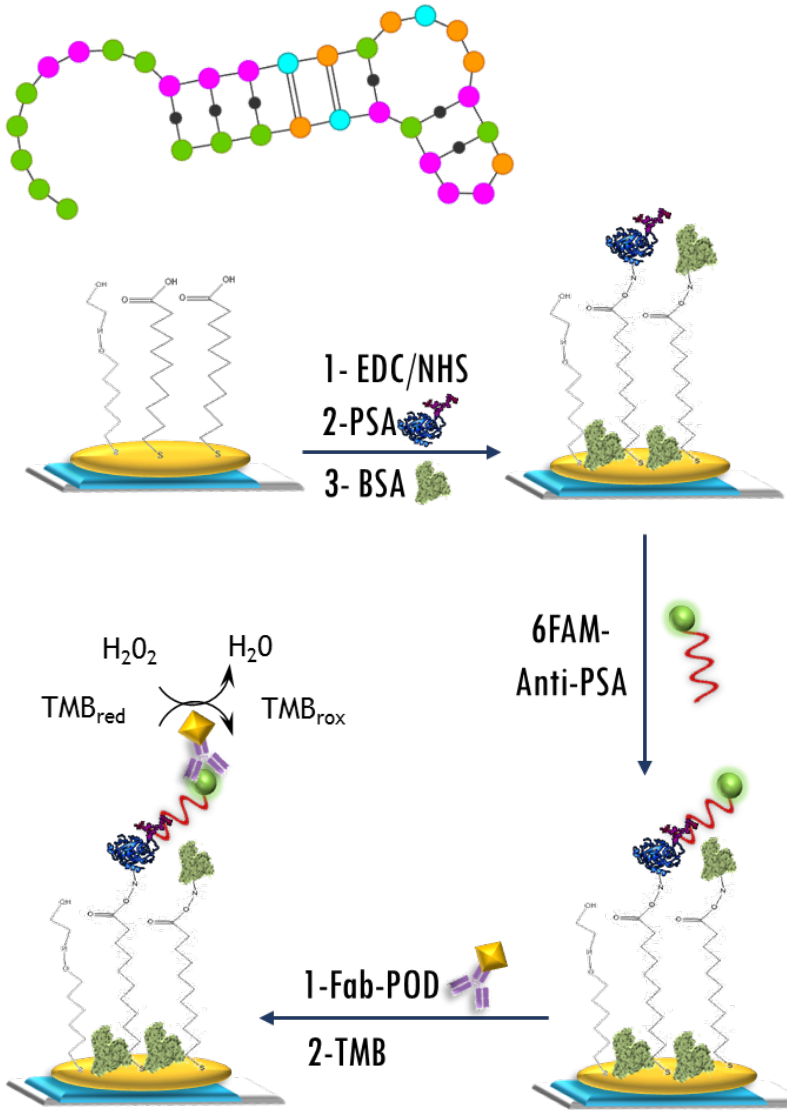

6FAM-TTTTTAATTAAAGCTCGCCATCAAATAGCTTT

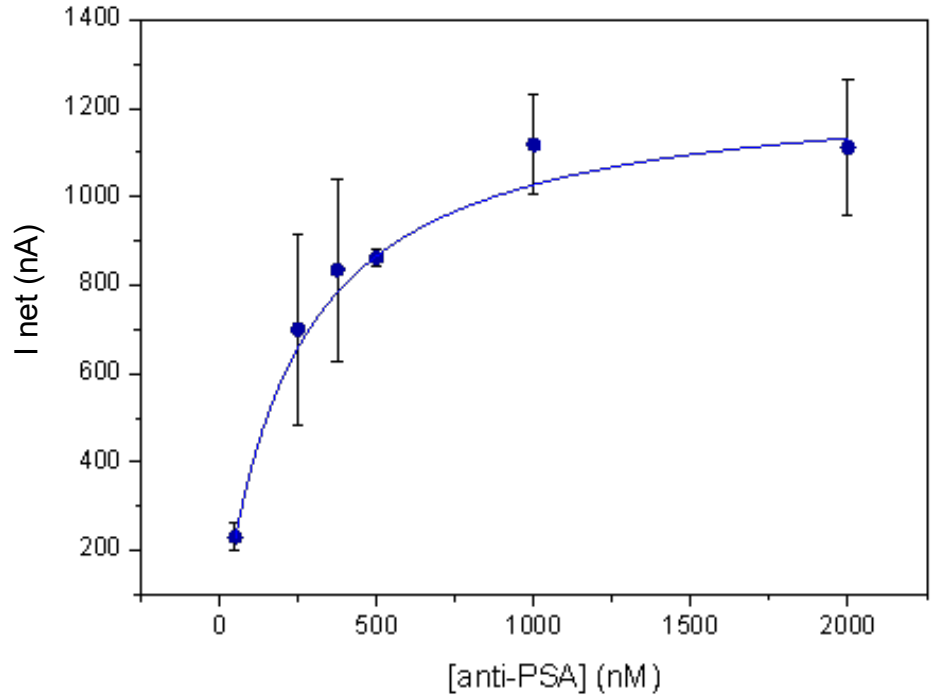

$K_D = 229 \pm 25 \text{ nM}$

*Biosensors and Bioelectronics ,26,2010,1386-1391

BINDING OF ANTI-PSA APTAMER

6FAM-TTTTTAATTAAAGCTCGCCATCAAATAGCTTT

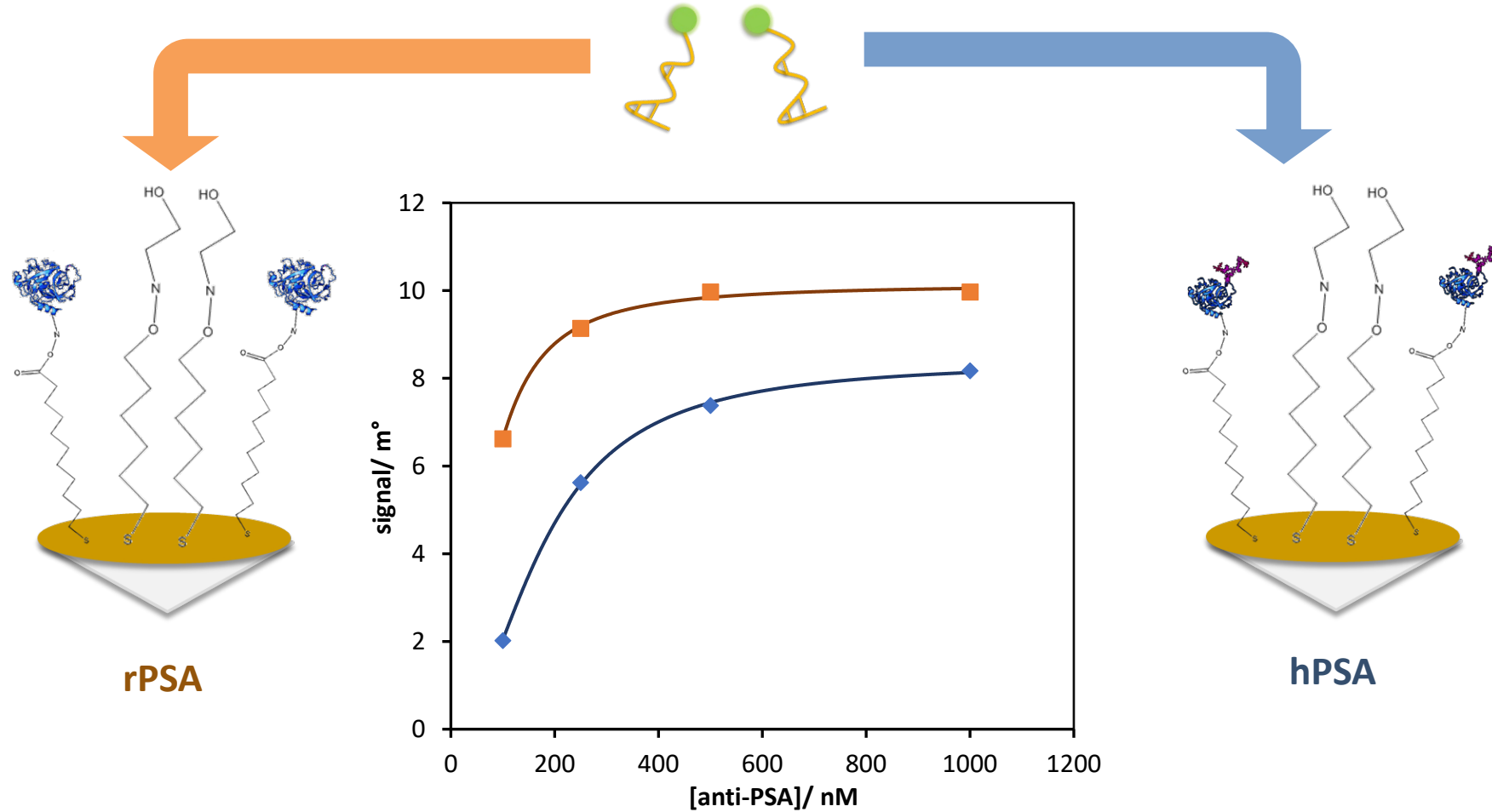

The described aptamer is not able to recognise the glycans

SELECTION OF APTAMERS

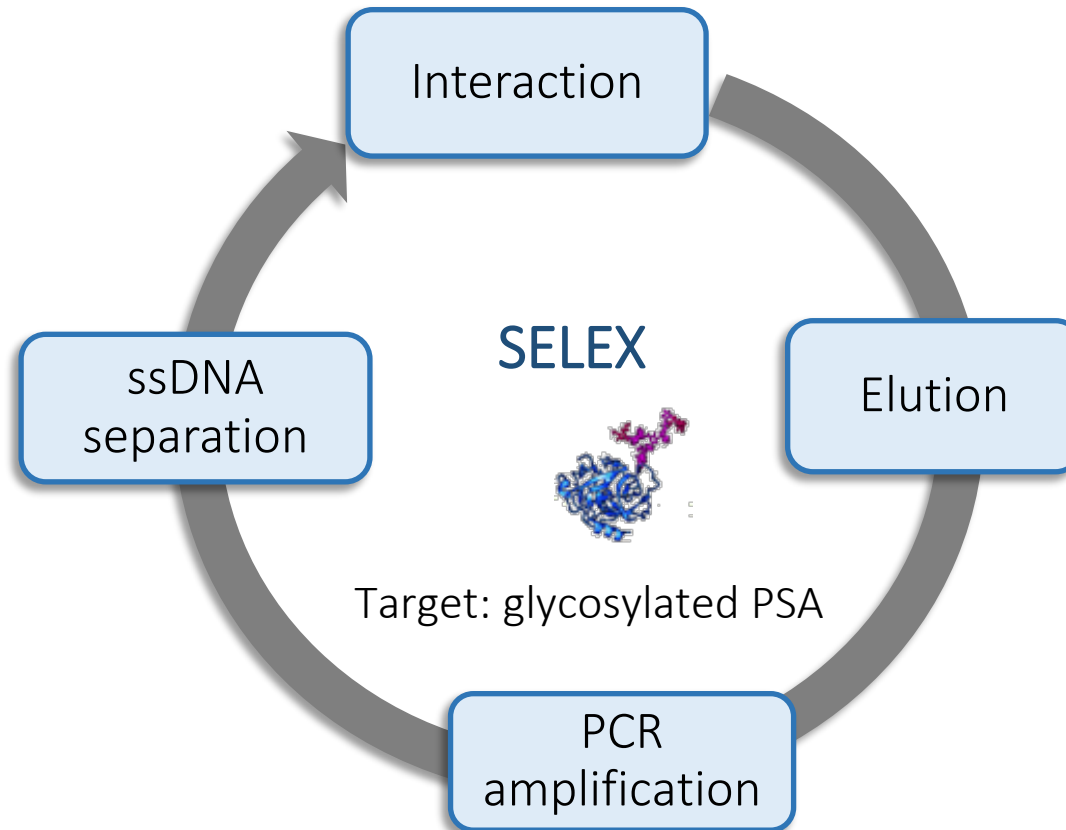

Hypothesis: The incorporation of counter-selection against recombinant PSA would allow to direct the selection towards the glycosylation site

SELECTION OF APTAMERS

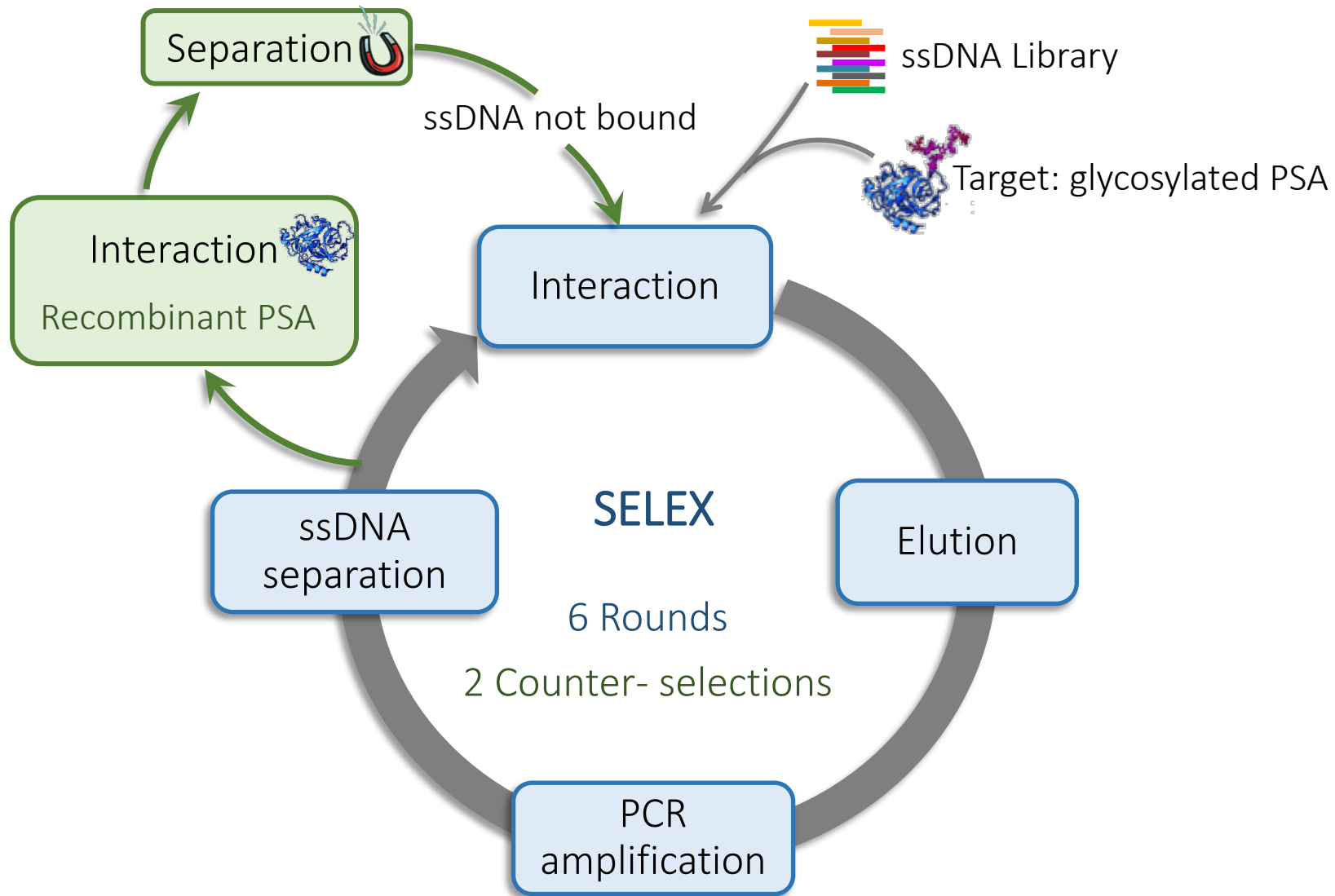

HIGH-THROUGHPUT SEQUENCING

High-throughput sequencing (HTS)

To identify the
Aptamer sequences in
the enriched library

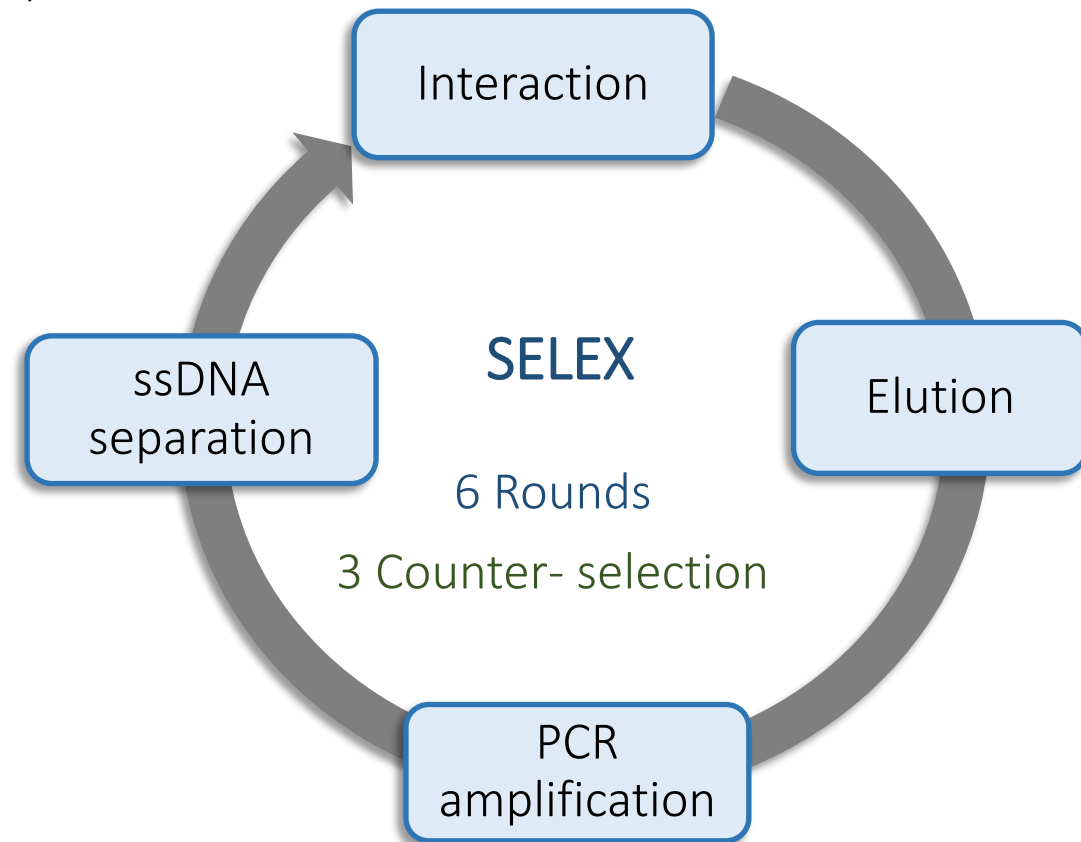

Clone	Sequence
PSA-1	GGACGGTTGCGCTATATTTAACCAAAAGTCTGGATTAACA----
PSA-2	T.....GAT.GATGCCA.CG.TGT.C.ATATTTG.G...----
PSA-3	.CTATC.G.T.G.TGG.G..GTTGCGT.GG.TTG.....TG----
PSA-4	AA..A.CG.TC.CCC..GGGGT..TGAC.AC CGGGGT.T----
PSA-5	----...CAA.TCTCG..A.GT.G.CT..A.TCT.C.GGCGCCT

CHARACTERIZATION OF APTAMER PSA-1

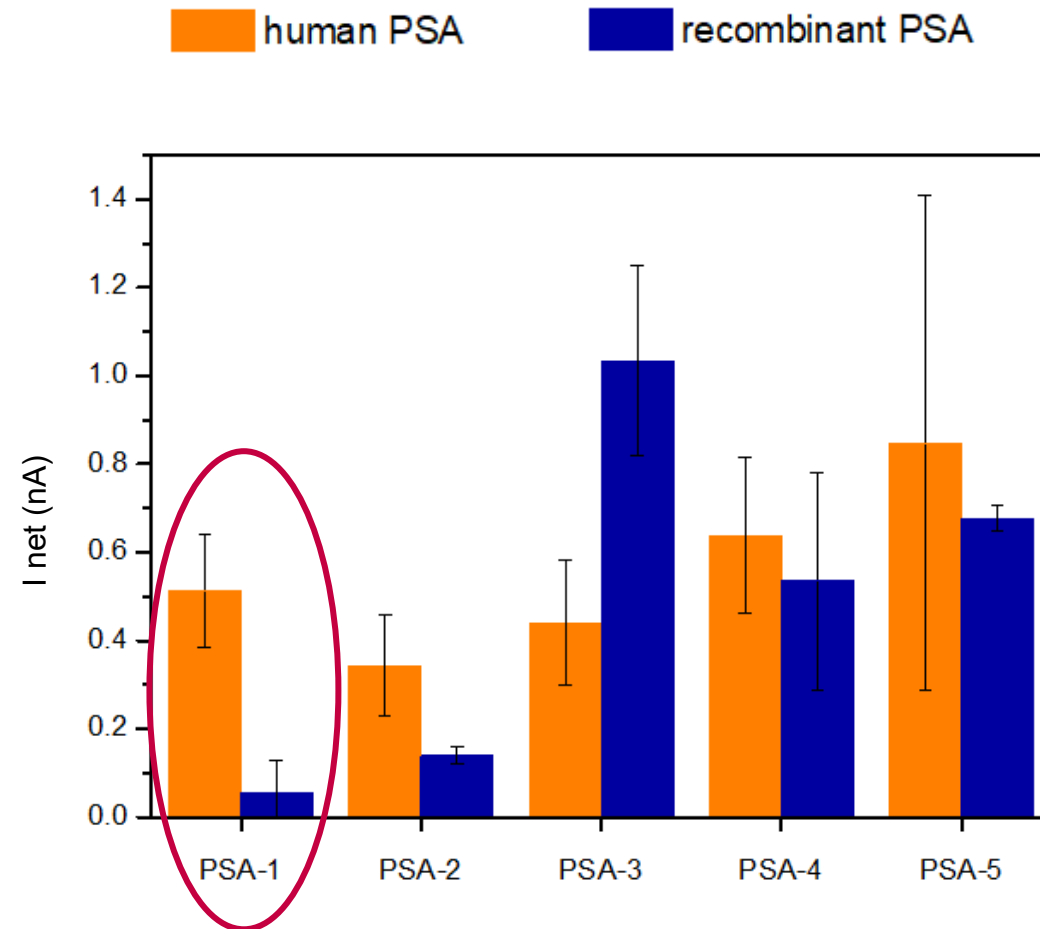
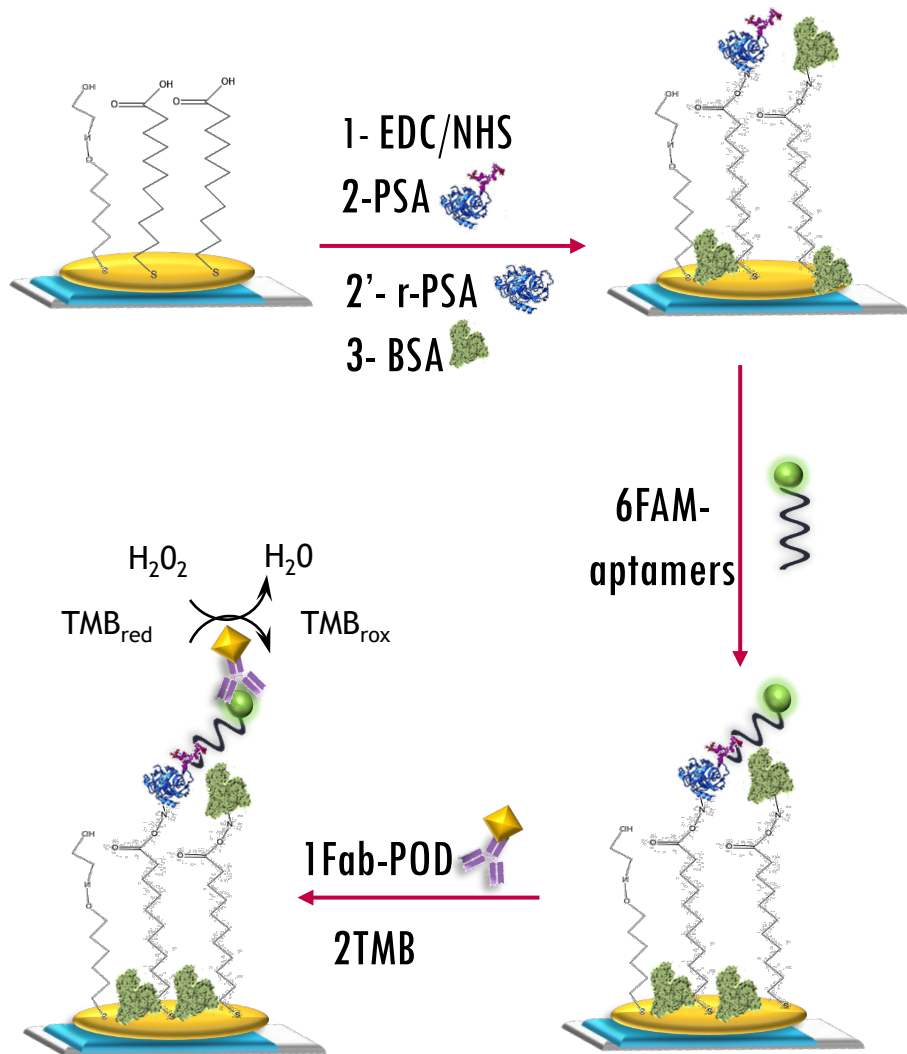

PSA-1 recognises the glycosylation moiety

CHARACTERIZATION OF APTAMER PSA-1

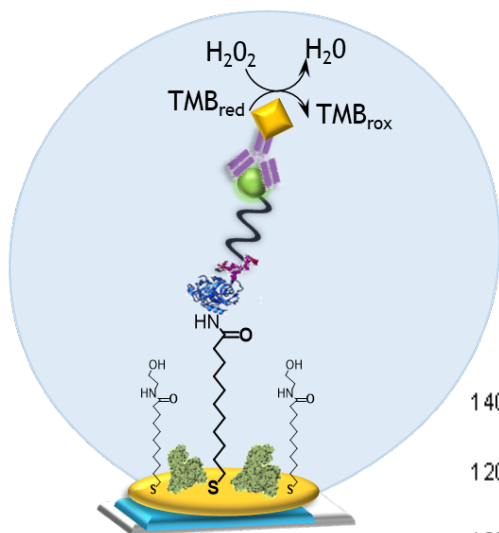

AFFINITY CURVE

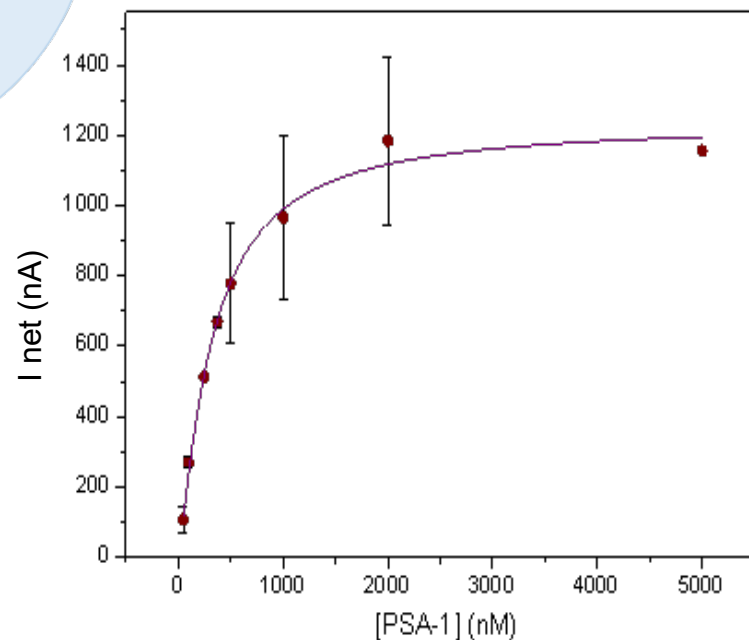

$$K_D = 357 \pm 42 \text{ nM}$$

SELECTIVITY AGAINST OTHER PROTEINS

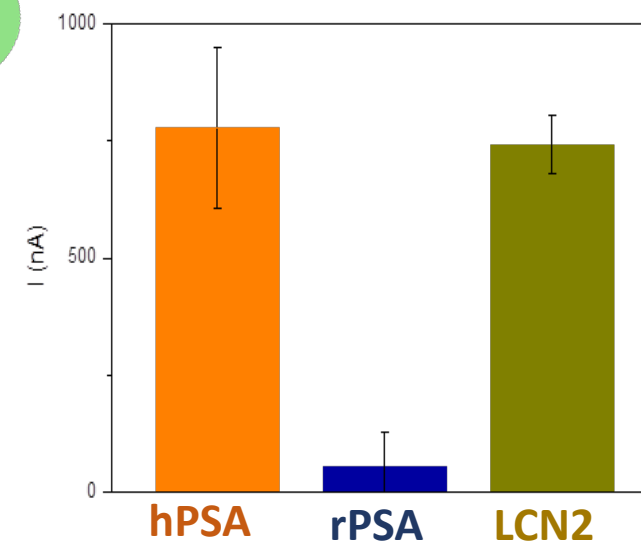
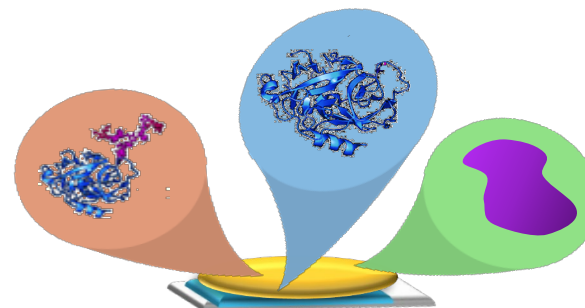

PSA-1 recognises the glycans of other glycoproteins and does not recognise proteins without glycans

PSA-1 is directed only to the glycosylation moiety

SELECTION OF APTAMERS

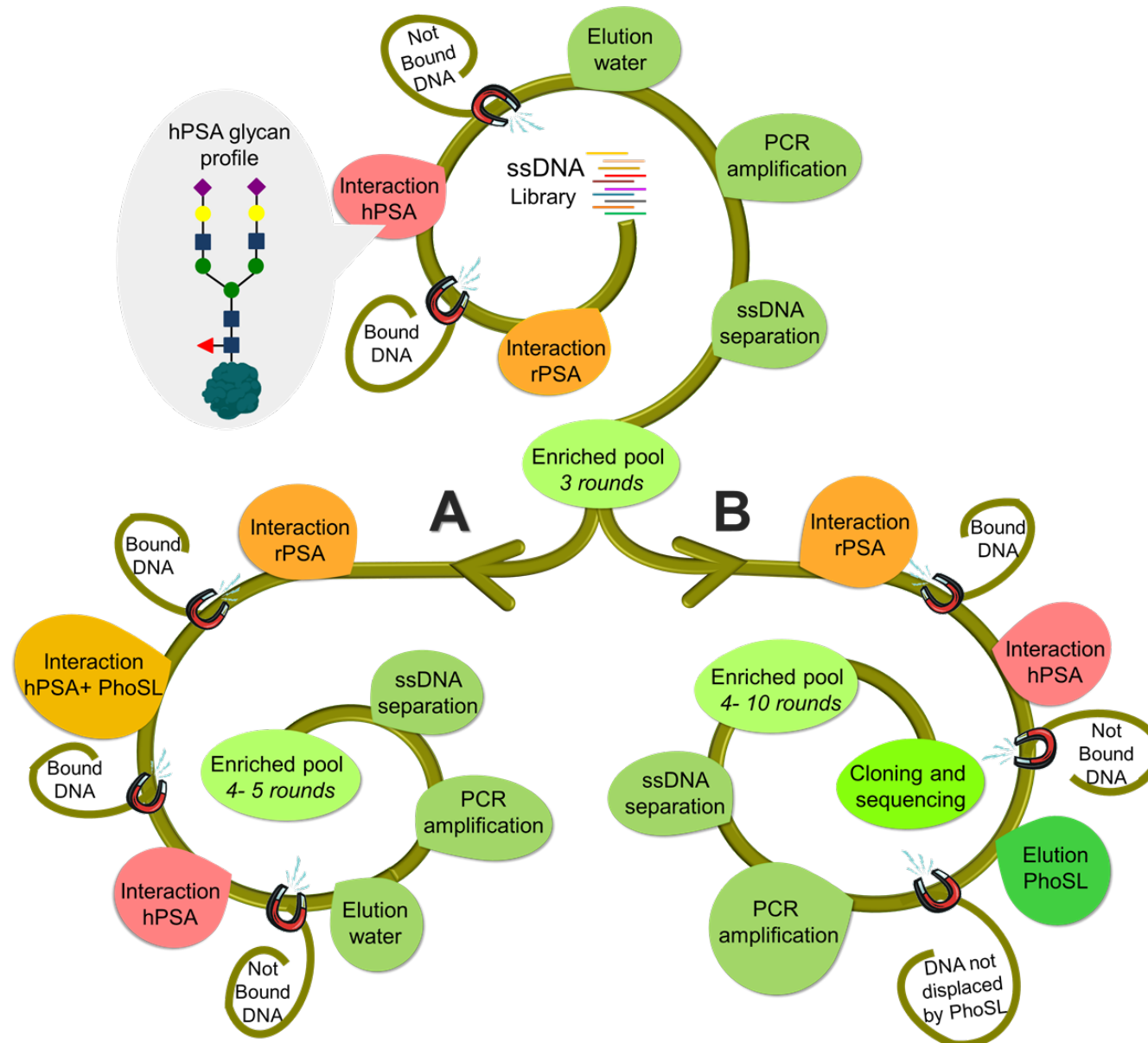

EVOLUTION OF THE SELEX

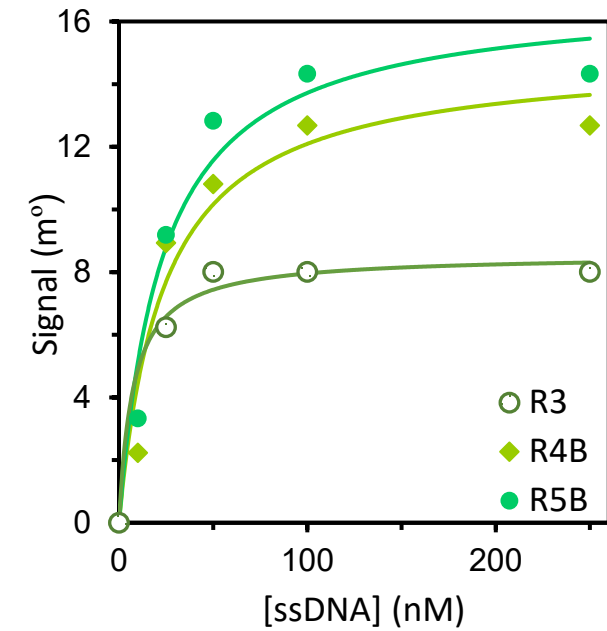
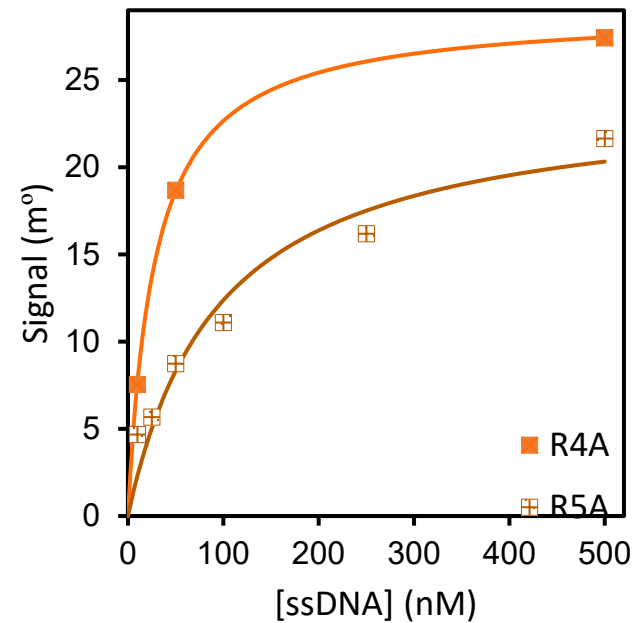
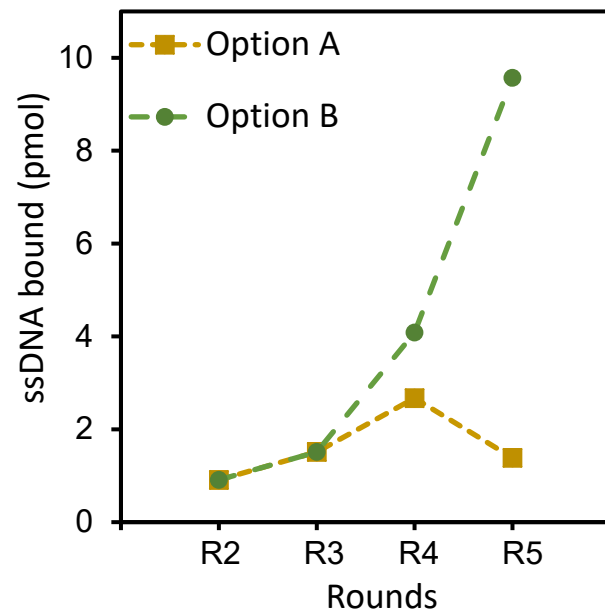
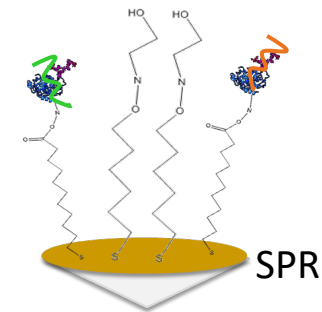
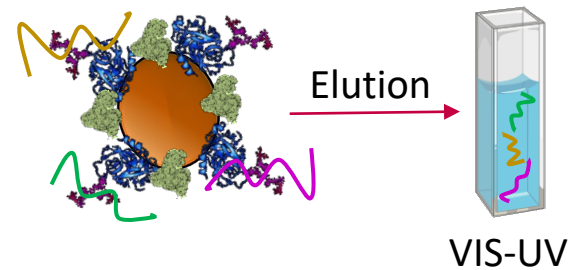

Option B (elution with the lectin) allows a higher enrichment of the initial pool

SELECTION OF APTAMERS

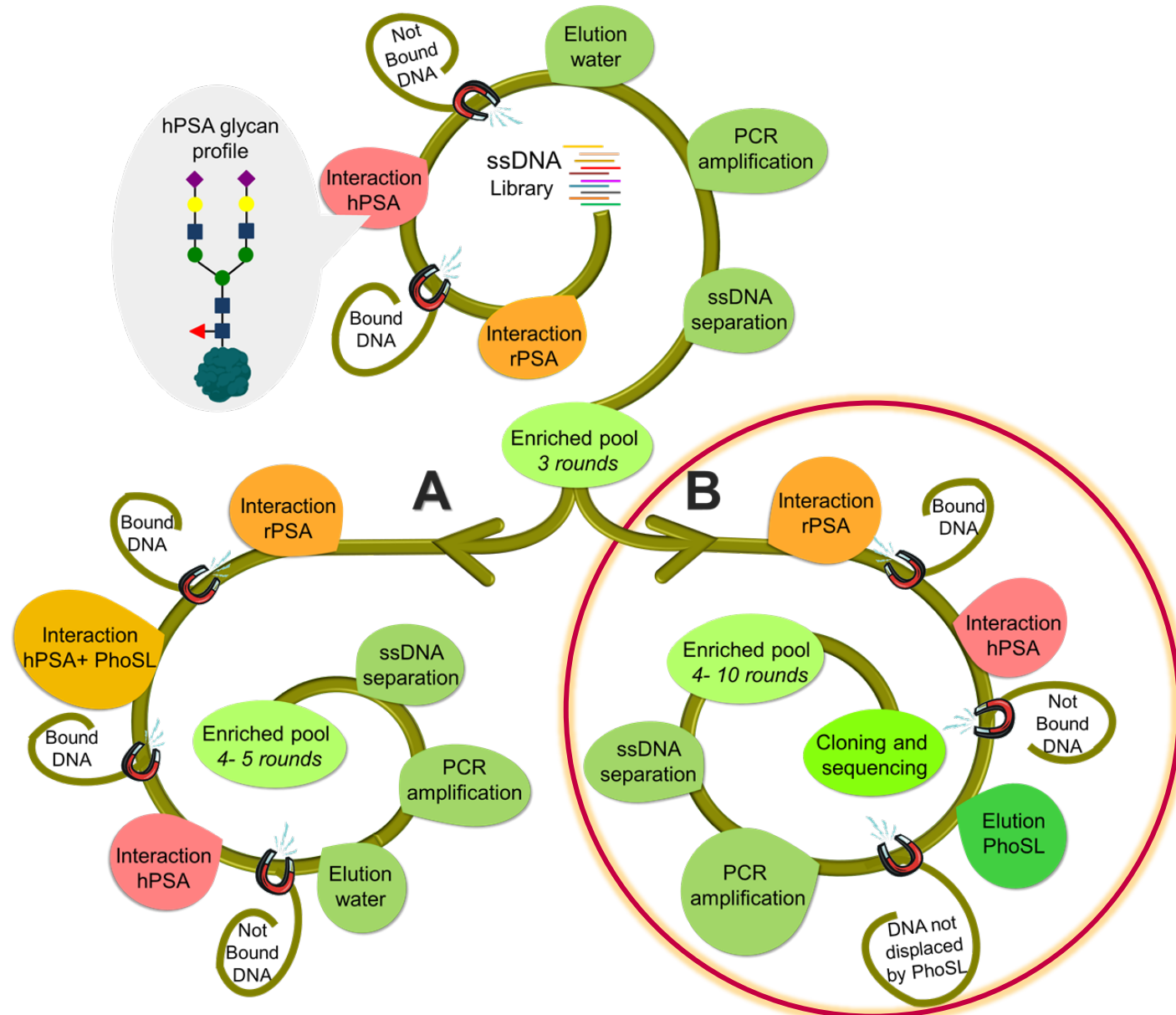

CHARACTERIZATION OF APTAMER PSAG-1

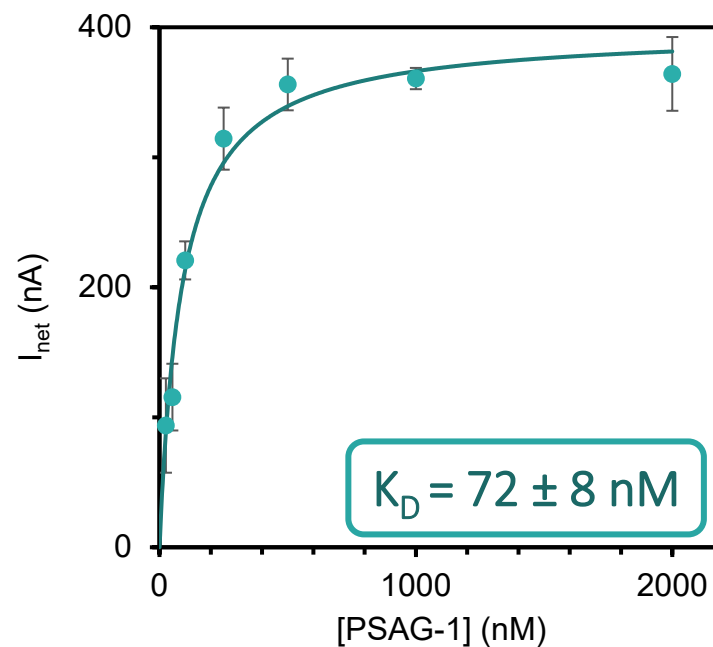
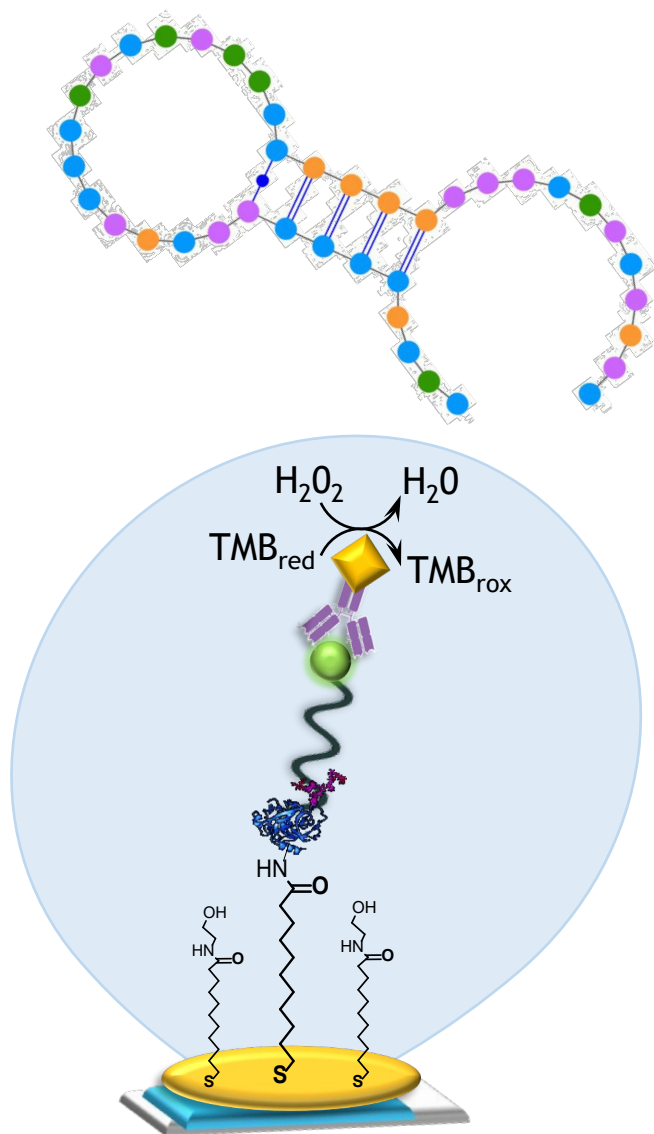

PSAG-1 is directed to the glycosylation site: recognising glycan and peptide

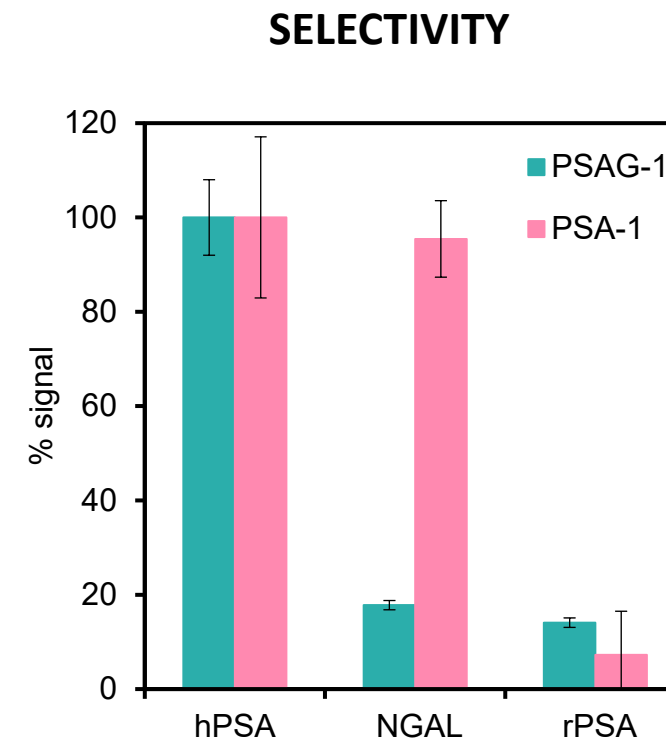

CHARACTERIZATION OF APTAMERS

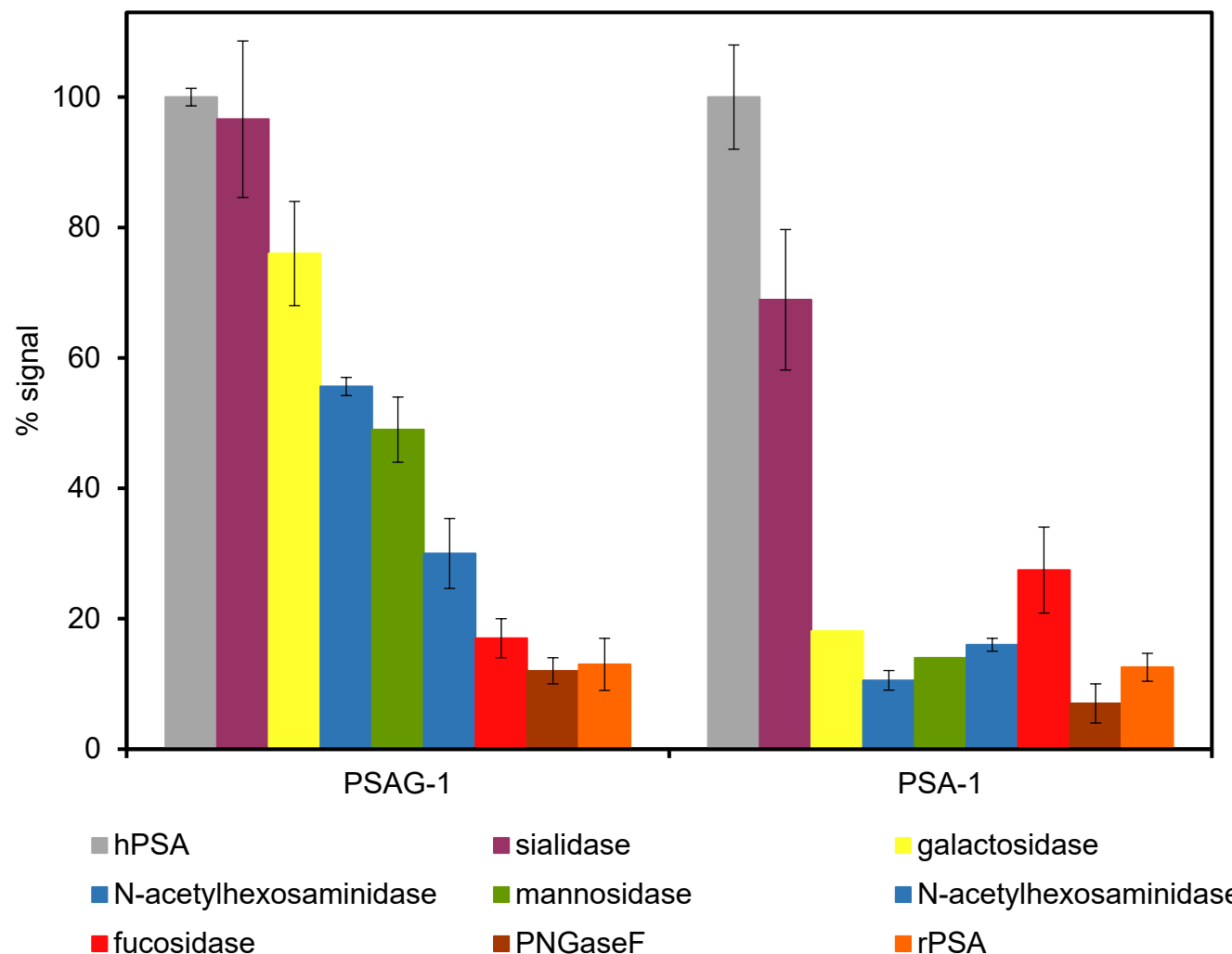
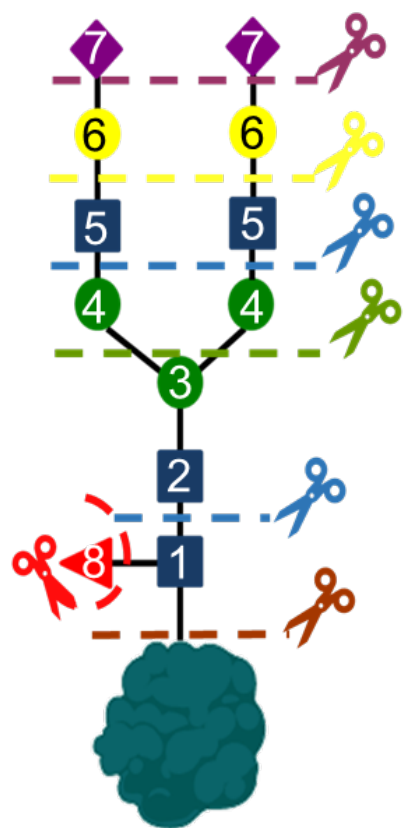

PSAG-1 recognises different sugars than PSA-1

A. Díaz-Fernández, R. Miranda-Castro, N. Díaz, D. Suárez, N. de-los-Santos-Álvarez & M. J. Lobo-Castañón. *Chemical Science*, 2020, 11, 9402-9413.

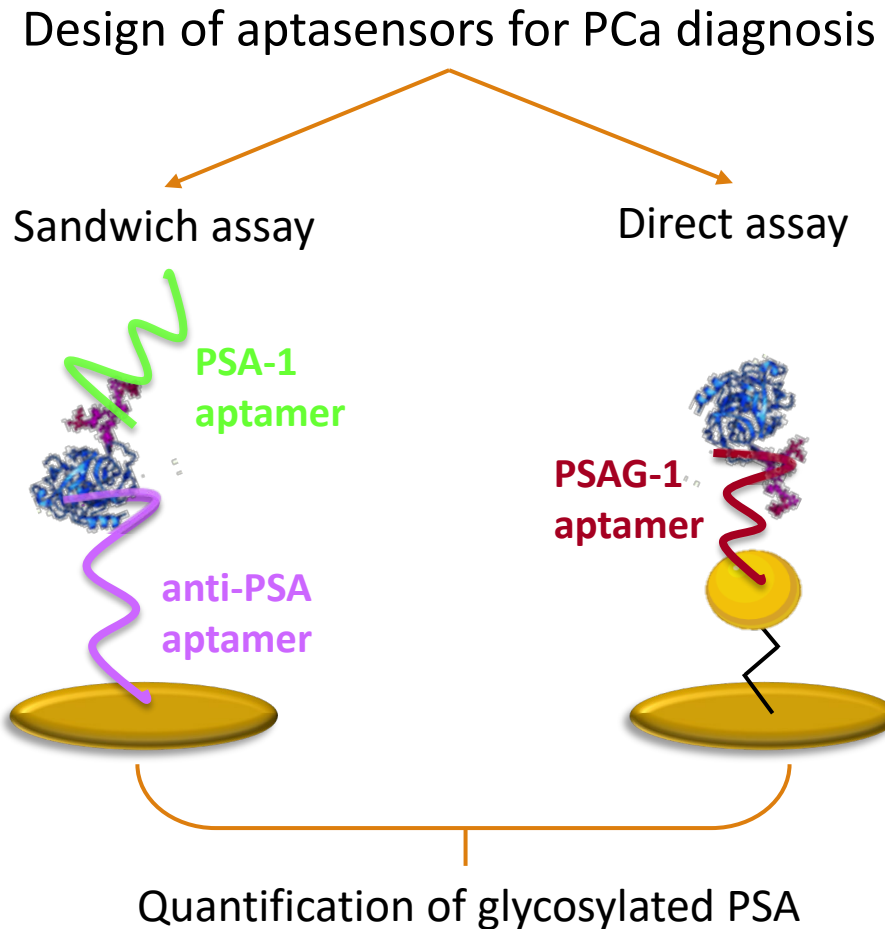

ELECTROCHEMICAL APTASENSORS

- Two different formats to detect glycosylated PSA in human serum

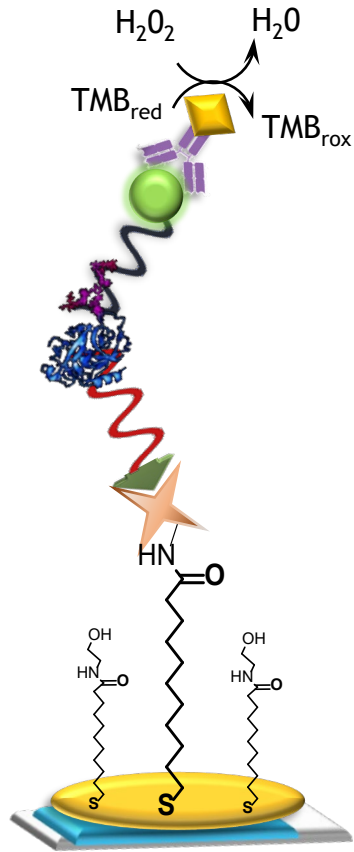

DESCRIPTION OF THE SANDWICH ASSAY



- Capture aptamer 
 - Aptamer described for PSA
 - Labelled with biotin
 - Recognise the peptide part of the PSA
- Detection aptamer 
 - Aptamer obtained in the SELEX
 - Labelled with fluorescein
 - Recognise the glycans of the PSA

Streptavidin



PSA

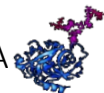

Fab-POD



SANDWICH ASSAY

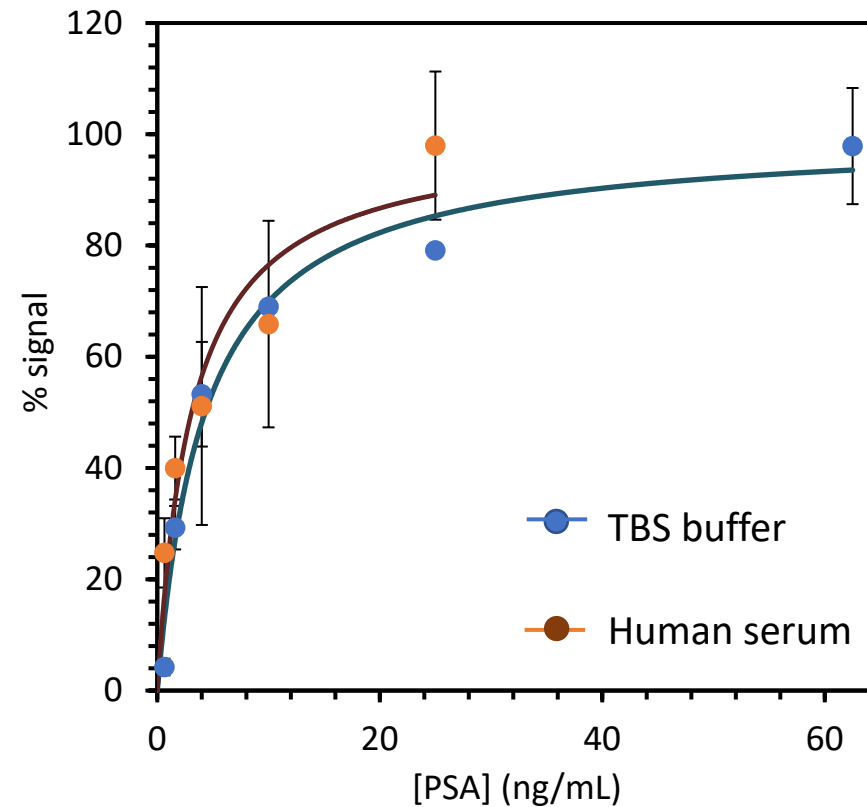

- Aptamer specific buffer TBS

Working range: 0.64 ng/mL – 62.5 ng/mL

- Human serum

Working range : 0.64 ng/mL – 25 ng/mL

SANDWICH ASSAY-SELECTIVITY

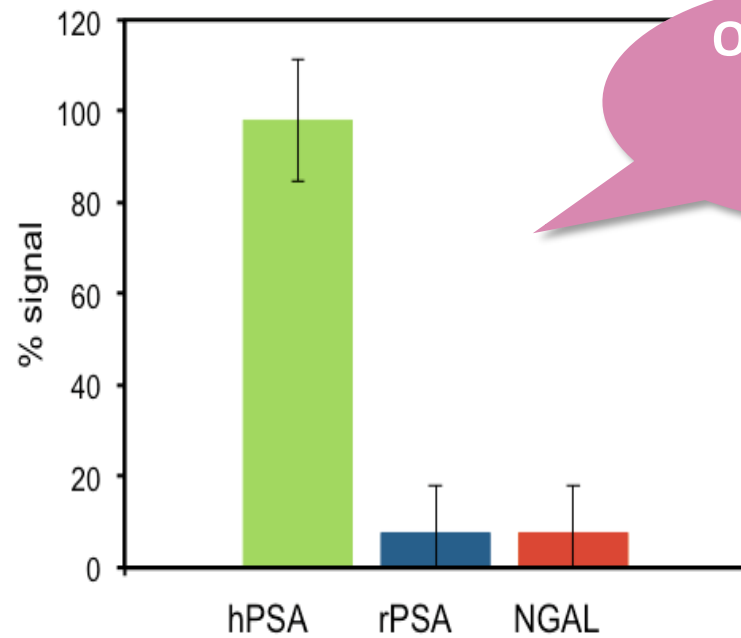

Lyphochek Immunoassays Plus control
A serum based control with **92 analytes**

Control	Concentration found	Concentration BIO-RAD control	
		fPSA	tPSA
Level 2	1.9 ± 0.4 ng/mL	1.06 ± 0.05 ng/mL	1.88 ± 0.1 ng/mL
Level 3	14 ± 3 ng/mL	9.7 ± 0.5 ng/mL	15.5 ± 0.9 ng/mL

Excellent selectivity

SANDWICH ASSAY-SERUM SAMPLES

Analysis of PSA levels in serum samples from patients with different pathologies

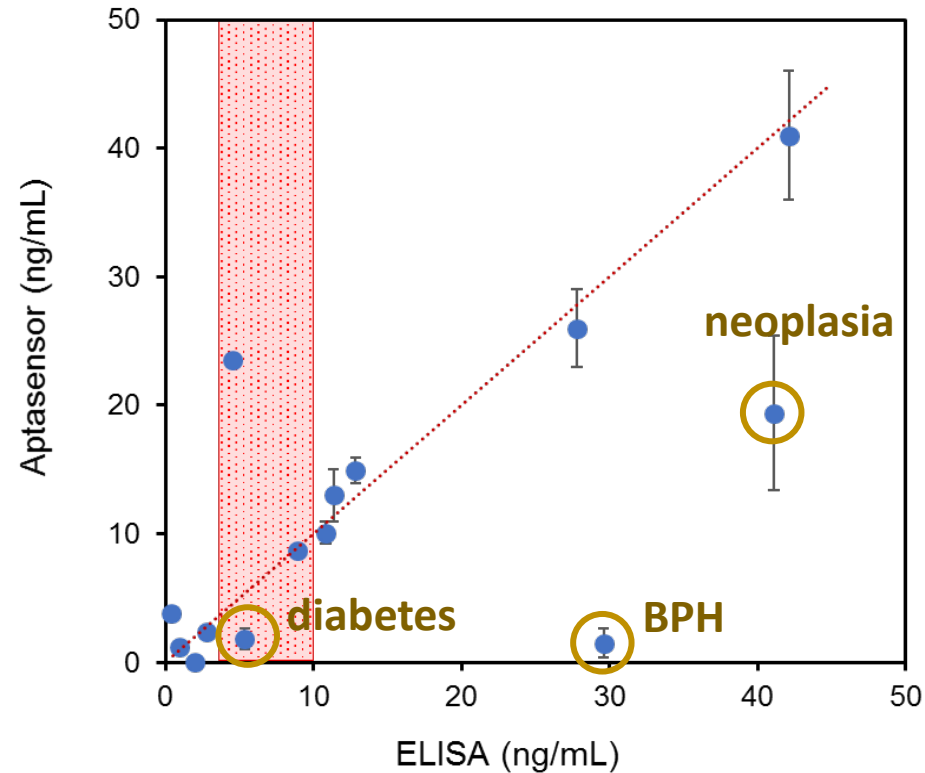

60% samples gives **concordant** values by both methods

Discordant values → other pathologies

2 samples **overdiagnosis** with **ELISA** → **correct diagnosis** with **aptasensor**: no cancer

DESCRIPTION OF THE APTASENSOR

- Gold evaporated electrodes

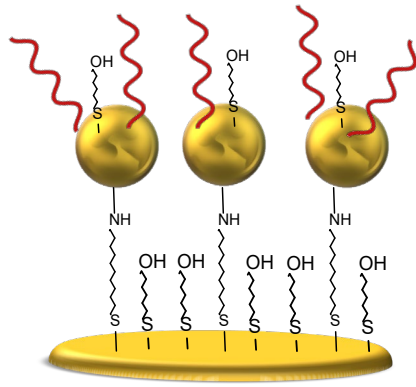

1- SAM formation

- 11-amino1-undecanethiol, 4 °C, overnight
- 1 mM MCH, RT, 1 hour

2. Gold nanoparticles

3. Aptamer/MCH 1:100

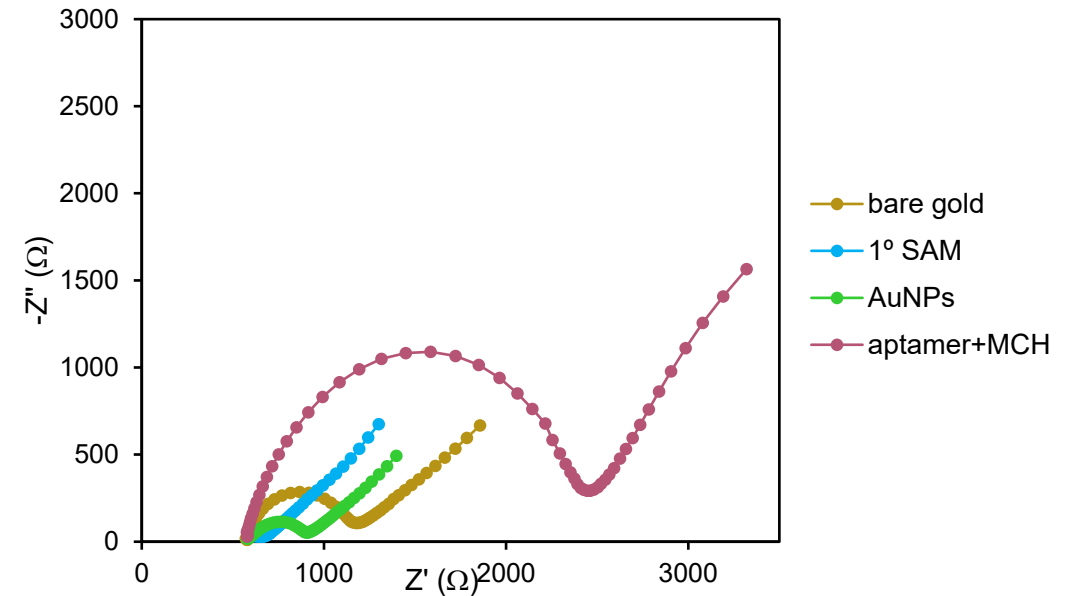

DESCRIPTION OF THE APTASENSOR

- Gold evaporated electrodes

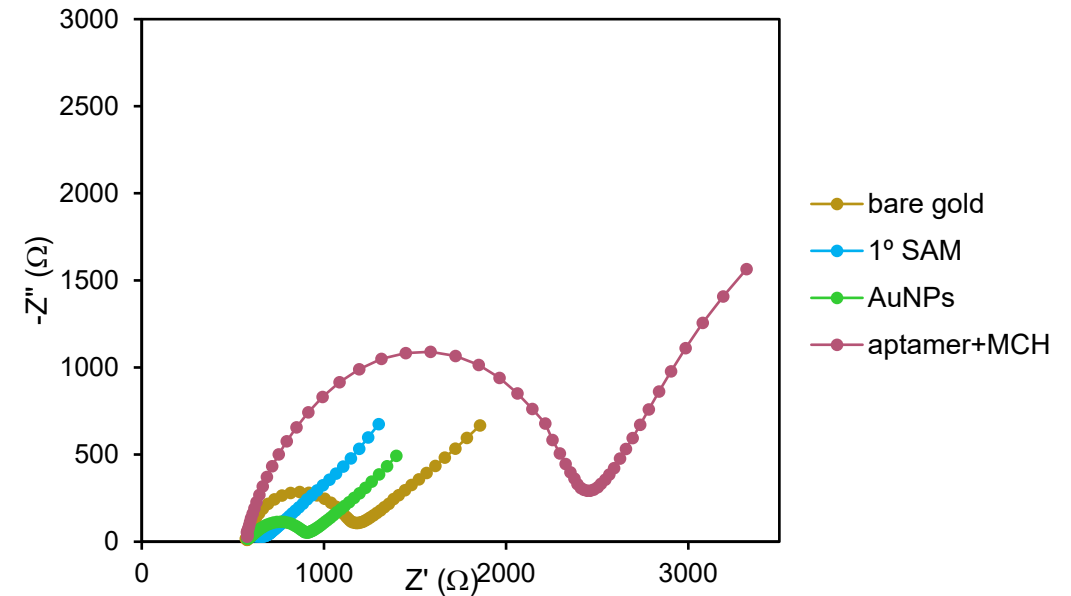
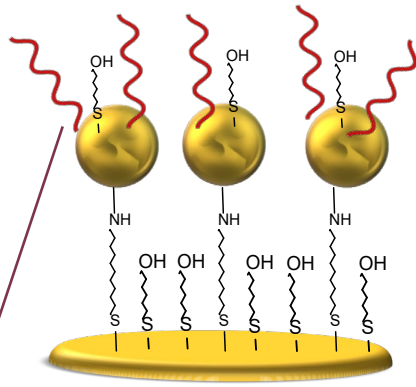

Two different aptamers on different surfaces

- anti-PSA: recognises total PSA
- PSAG-1; recognises the glycans of PSA

DESCRIPTION OF THE APTASENSOR

■ Gold evaporated electrodes

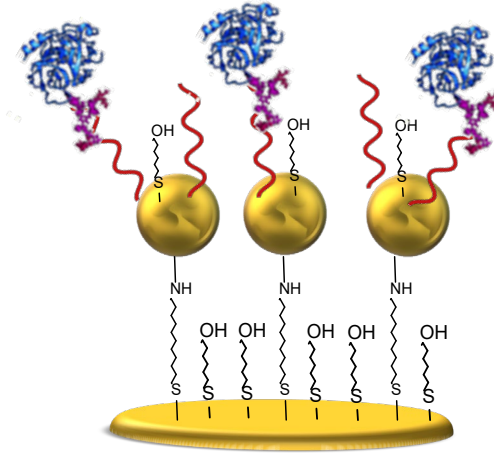

1. SAM formation

- 11-amino1-undecanethiol, 4 °C, overnight
- 1 mM MCH, RT, 1 hour

2. Gold nanoparticles

3. Aptamer/MCH 1:100

4. PSA detection

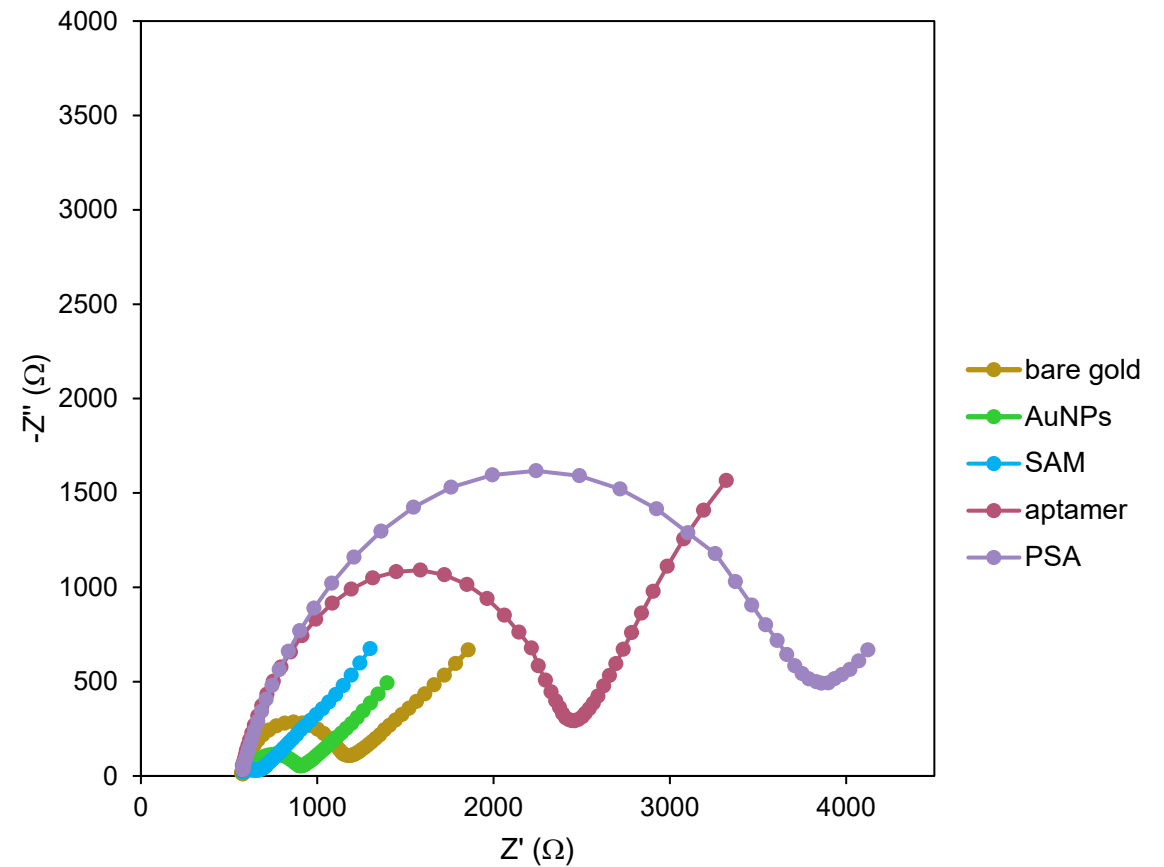

RESPONSE OF THE APTASENSOR

- PSAG-1 calibration curve in buffer

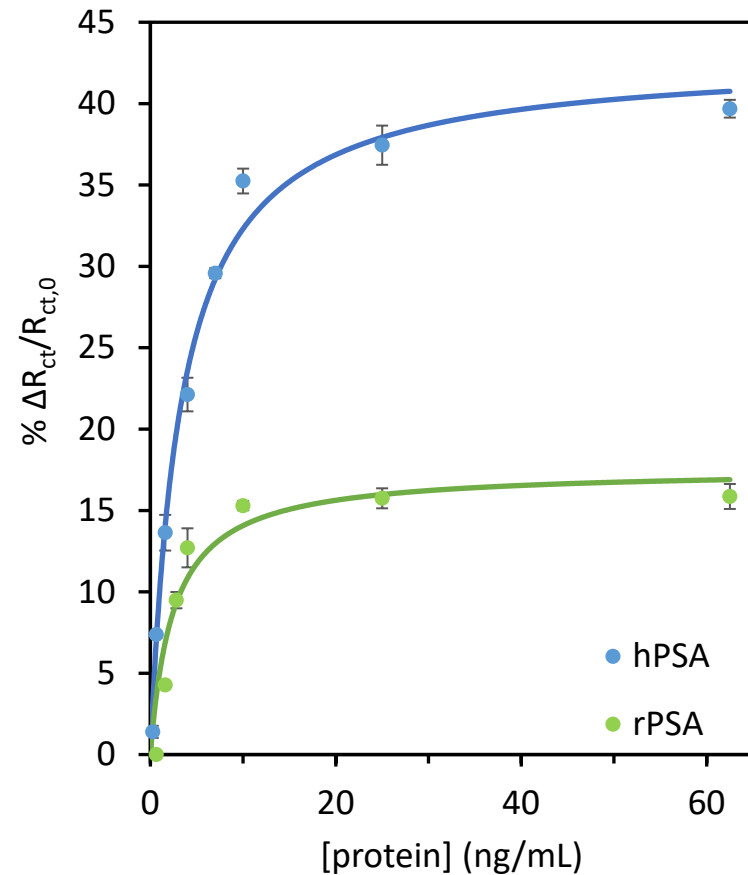

- PSAG-1 calibration curve: information about the amount of glycosylated PSA in a sample

- Anti-PSA calibration curve in buffer

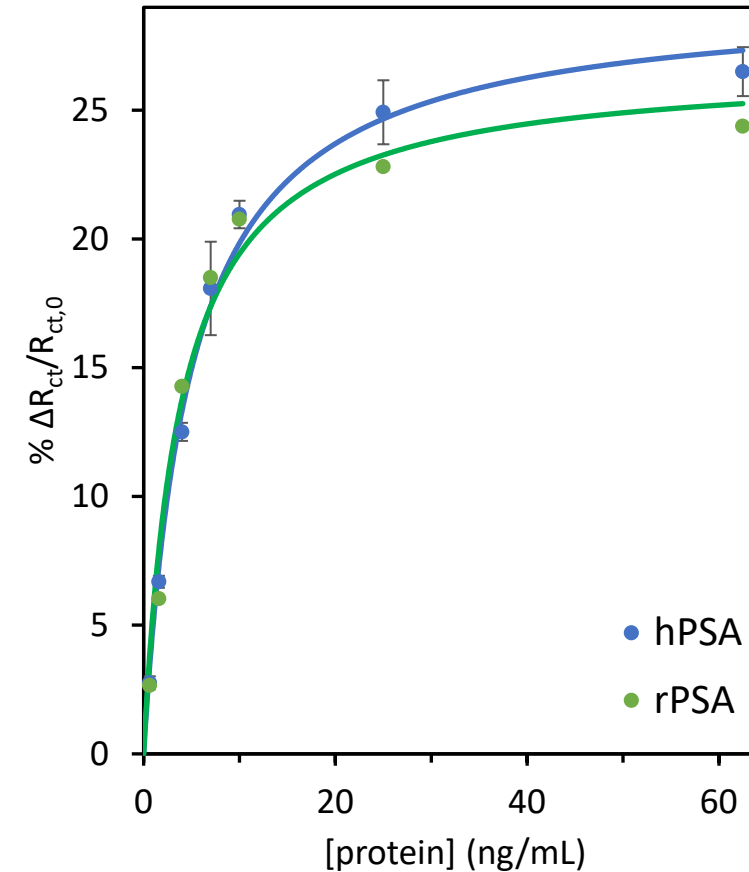

- Anti-PSA calibration curve: information about the amount of total PSA in a sample.

RESPONSE OF THE APTASENSOR- human serum

- PSAG-1 calibration curve in serum

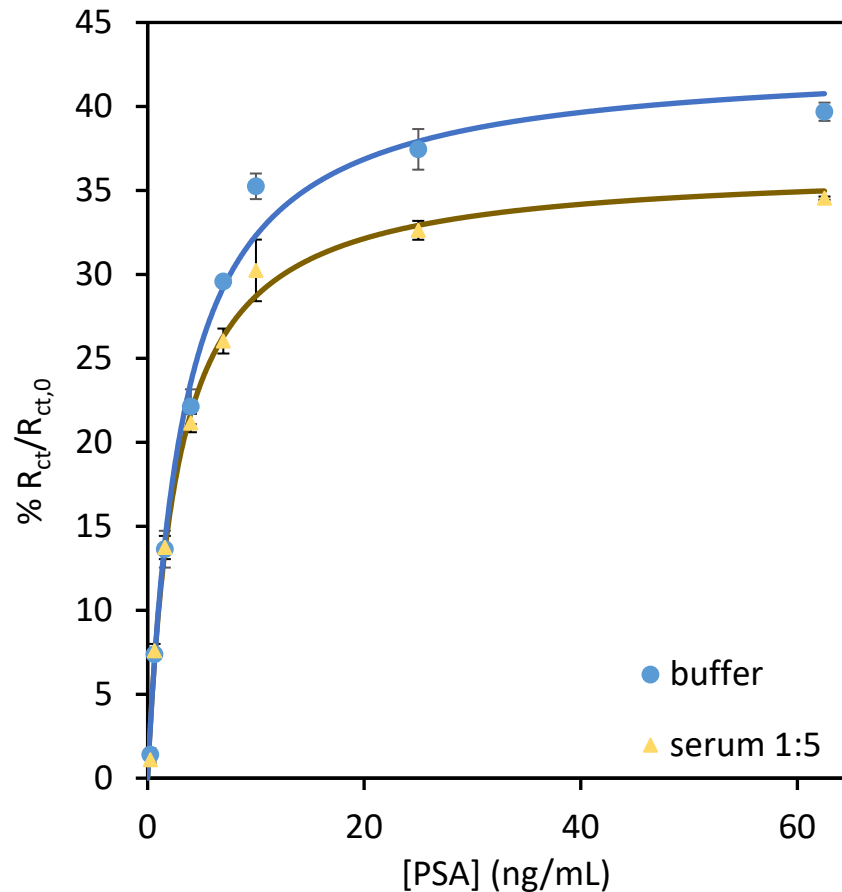

Working range in serum diluted 1/5: 0.256-62.5 ng/mL PSA

- Anti-PSA calibration curve in serum

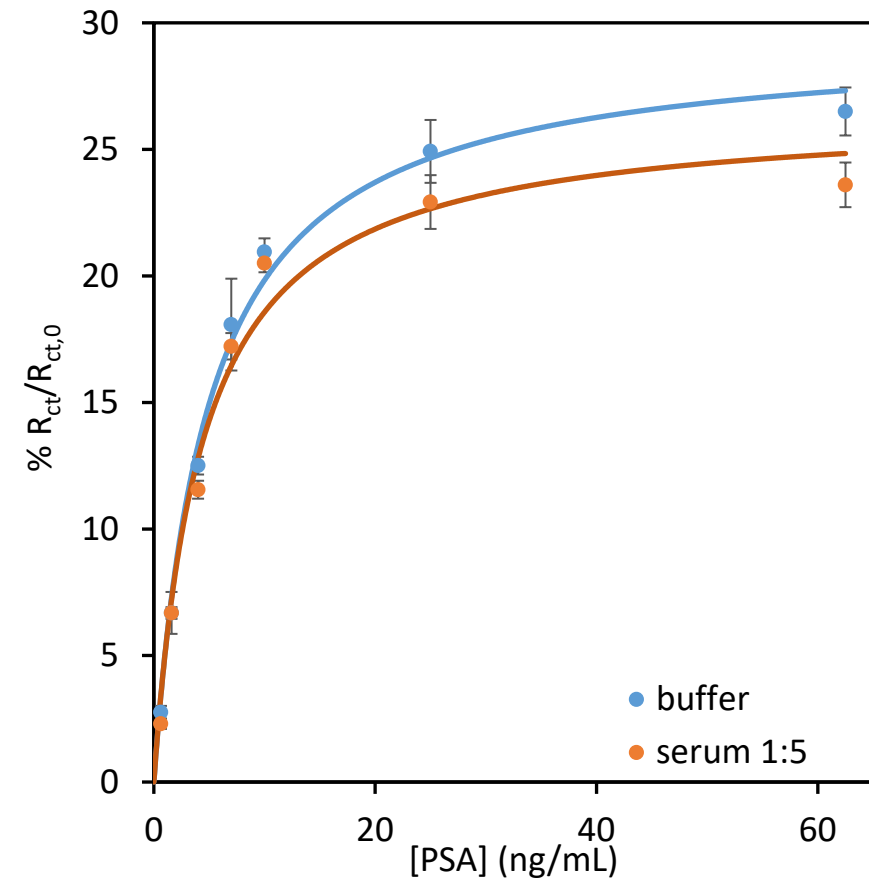

Working range in serum diluted 1/5: 0.64- 62.5 ng/mL PSA

ANALYSIS OF SERUM SAMPLES

Analysis of PSA levels in serum samples from patients with different pathologies

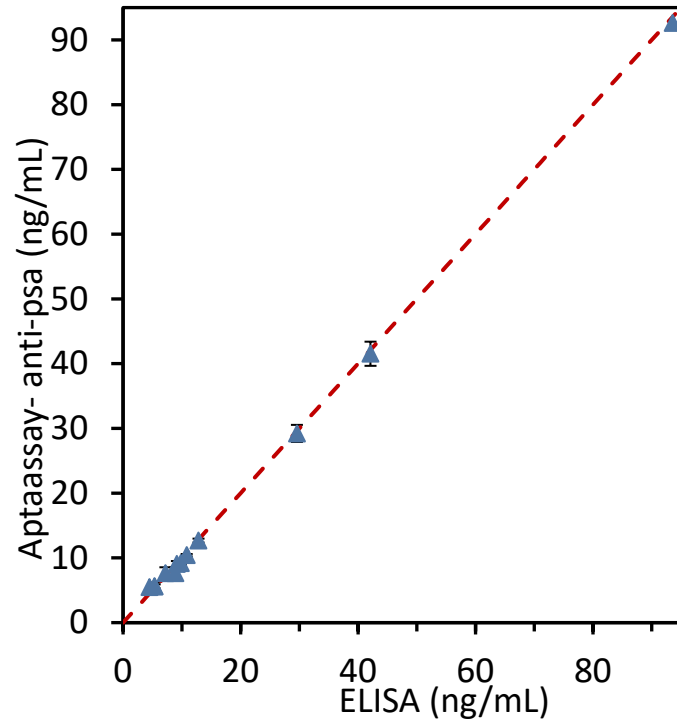

Aptaassay PSAG-1

Sample	[PSA] with PSAG-1	ELISA value	Diagnosis
1	2.6	9.83	Diabetes, hypertension
2	1.21	5.36	diabetes
3	2.53	9.15	aortic prosthesis
4	1.74	7.2	morbid obesity

100% samples gives **concordant** values by both methods with anti-PSA aptamer

Discordant values with PSAG-1 aptamer → **Other pathologies**

overdiagnosis with ELISA → **correct diagnosis with aptasensor: no cancer**

CONCLUSIONS

- DNA aptamers obtained using as target the glycosylated form of a protein did not show any preferential recognition ability towards the glycosylation site.
- The inclusion of counter-selection with non-glycosylated forms of the protein may allow to direct the selection to the glycosylation moiety.
- One of the selected aptamers is able to recognise the glycosylation moiety, specifically the sialic acid and galactose of the glycan.
- A good design of the selection process may allow to direct the selection to the glycosylation site. The inclusion of counter-selection steps with non-glycosylated forms of the protein and elution step with a lectin may allow to direct the selection to the glycosylation site
- One of the selected aptamers is able to recognise the glycans and aminoacids of PSA
- The aptasensors, based on a sandwich or direct format, are able to recognise glycosylated PSA in human serum physiological range with an excellent selectivity.
- The aptasensors may provide an alternative approach for the detection of PSA, with potential to improve clinical outcomes of current PSA tests

ACKNOWLEDGMENTS



Raquel Sánchez Salcedo

Ramón Lorenzo Gómez

Clara Abardía Serrano

Dr. Rebeca Miranda Castro

Dr. Noemí de los Santos Álvarez

Prof. María Jesús Lobo Castañón

**Electroanalysis Research Group
University of Oviedo**



Dr. Pedro Estrela



Biosensor Research Laboratory



European Union
European Regional
Development Fund



CATCHING THE SUGARS: ELECTROCHEMICAL APTASENSORS FOR THE DETECTION OF CANCER-RELATED GLYCOSYLATION CHANGES IN PROSTATE SPECIFIC ANTIGEN

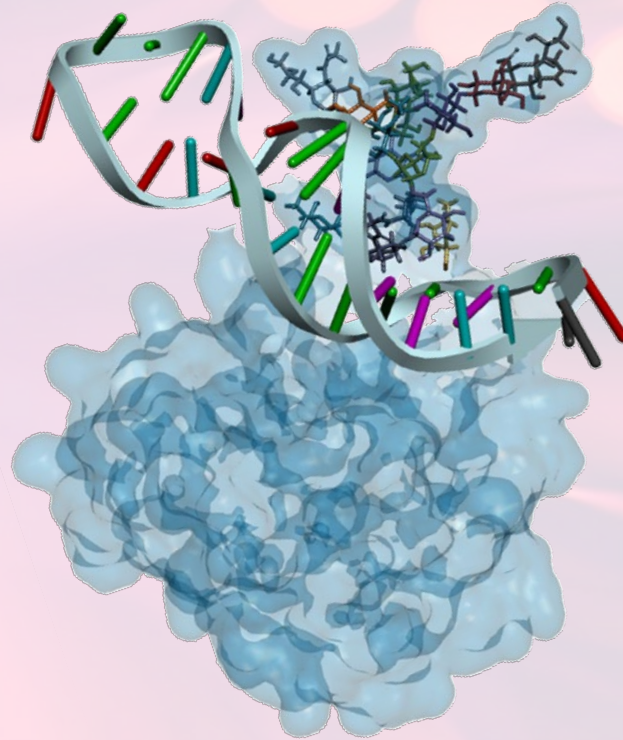

ANA DÍAZ FERNÁNDEZ

R. Miranda-Castro, P. Estrela, N- de-los-Santos-Álvarez, M.J. Lobo-Castañón



UNIVERSIDAD DE OVIEDO



UNIVERSITY OF
BATH

