



Microwave-assisted synthesis of TiO_2 -ZnO oxide systems with enhanced photocatalytic and photovoltaic activity

Adam Kubiak^{1,*}, Zuzanna Bielan², Aleksandra Bartkowiak³, Maciej Zalas³, Anna Zielińska-Jurek²,
Katarzyna Siwińska-Ciesielczyk¹, Teofil Jesionowski^{1,*}

¹Poznan University of Technology, Faculty of Chemical Technology, Institute of Chemical Technology and Engineering, Berdychowo 4, PL-60965 Poznan, Poland;

²Gdansk University of Technology, Faculty of Chemistry, Department of Process Engineering and Chemical Technology, Narutowicza 11/12, PL-80233 Gdansk, Poland;

³Adam Mickiewicz University, Poznan, Faculty of Chemistry, Uniwersytetu Poznanskiego 8, PL-61614 Poznan, Poland

Correspondence: adam.l.kubiak@doctorate.put.poznan.pl, teofil.jesionowski@put.poznan.pl

Plan of presentation

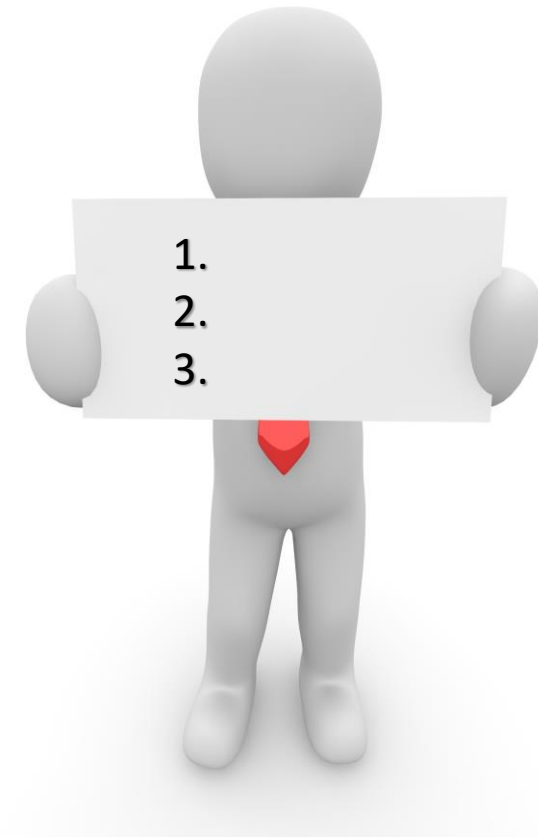
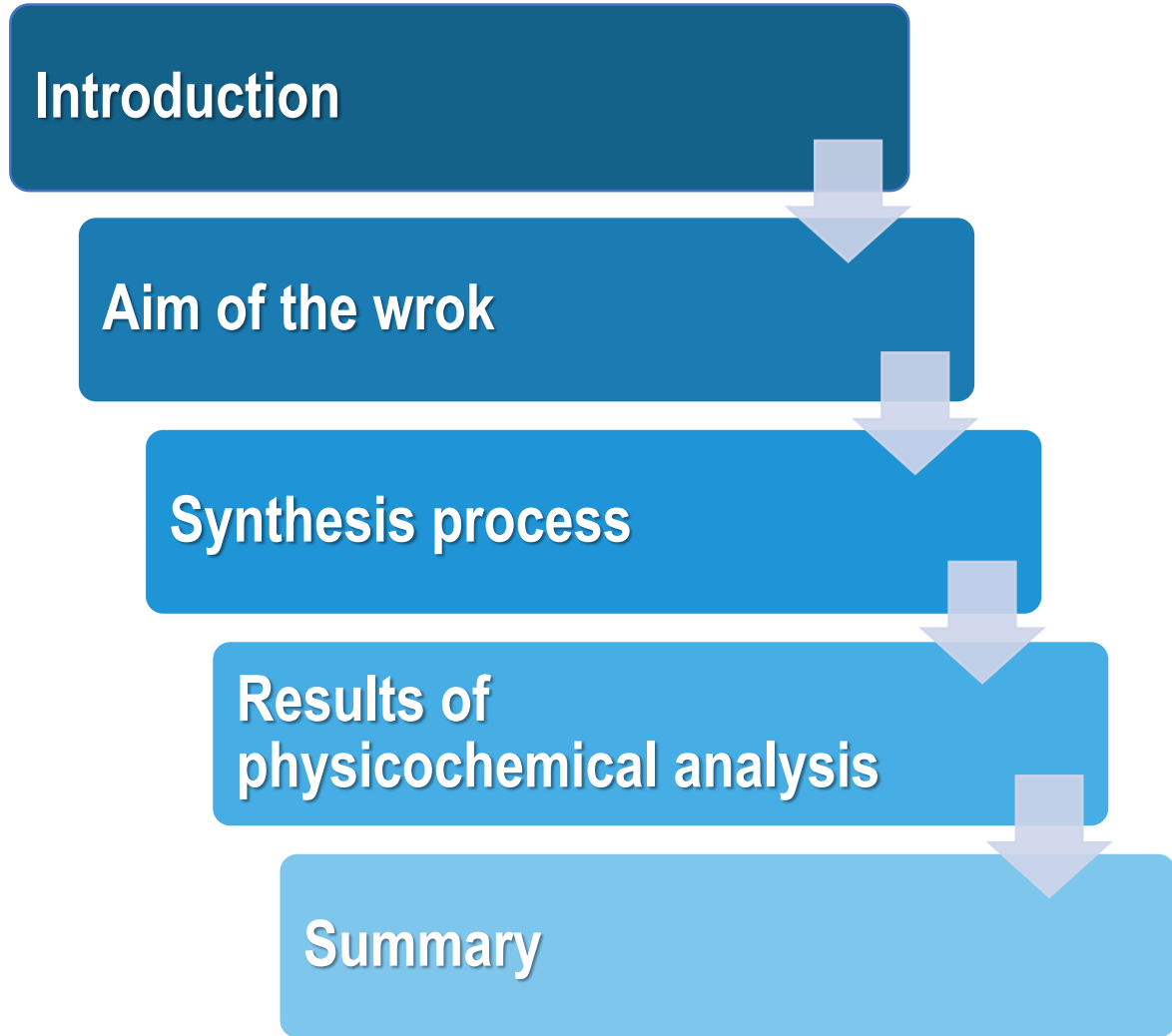



Titanium dioxide

- ✓ Polymorphic forms: anatase, rutile, brookite
- ✓ High thermal and mechanical stability
- ✓ Semiconductor properties (bandgap 3-3.2 eV)
- ✓ High refractive index 2.614 ($\lambda = 589.29 \text{ nm}$)
- ✓ Applications: pigment, photocatalysis, electrochemistry

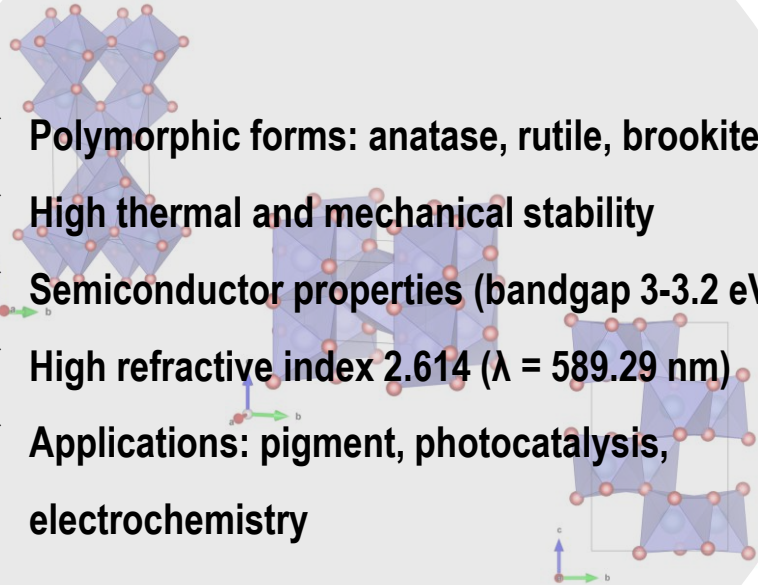

Zinc oxide

- ✓ Polymorphic forms: wurtzite, zincblende, rocksalt
- ✓ Semiconductor properties (bandgap 3,3 eV)
- ✓ Piezoelectric and antibacterial properties
- ✓ Applications: LEDs, lithium-ion batteries, medicine, photocatalyst

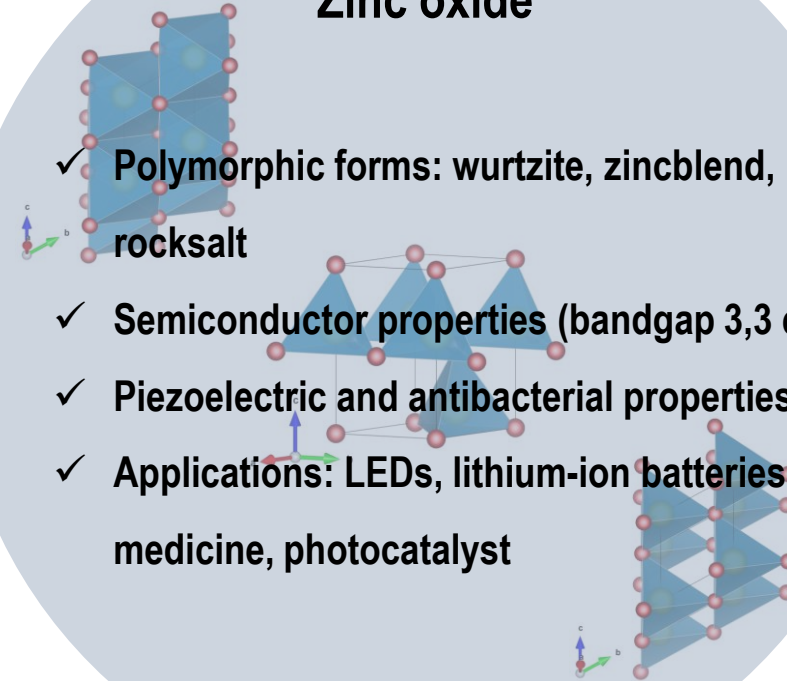

Introduction – microwave synthesis



- ✓ In the microwave heating process, heat is generated inside the material, the reactants absorb electromagnetic energy by volume and convert it into heat, **which allows the duration of the process to be shortened.**
- ✓ The use of microwave radiation as a heating source is determined by the use of an active substrate, i.e. one that has a dipole moment, **enabling a change in orientation in response to the changing electromagnetic field of microwave radiation.**
- ✓ The microwave technique is characterized by a high crystallization rate (higher reaction kinetics) and the formation of products with a **very narrow particle size distribution and controlled morphology.**
- ✓ Additionally the Scientists reported that the microwave synthesis can be **element of a broad strategy towards environmental protections.**

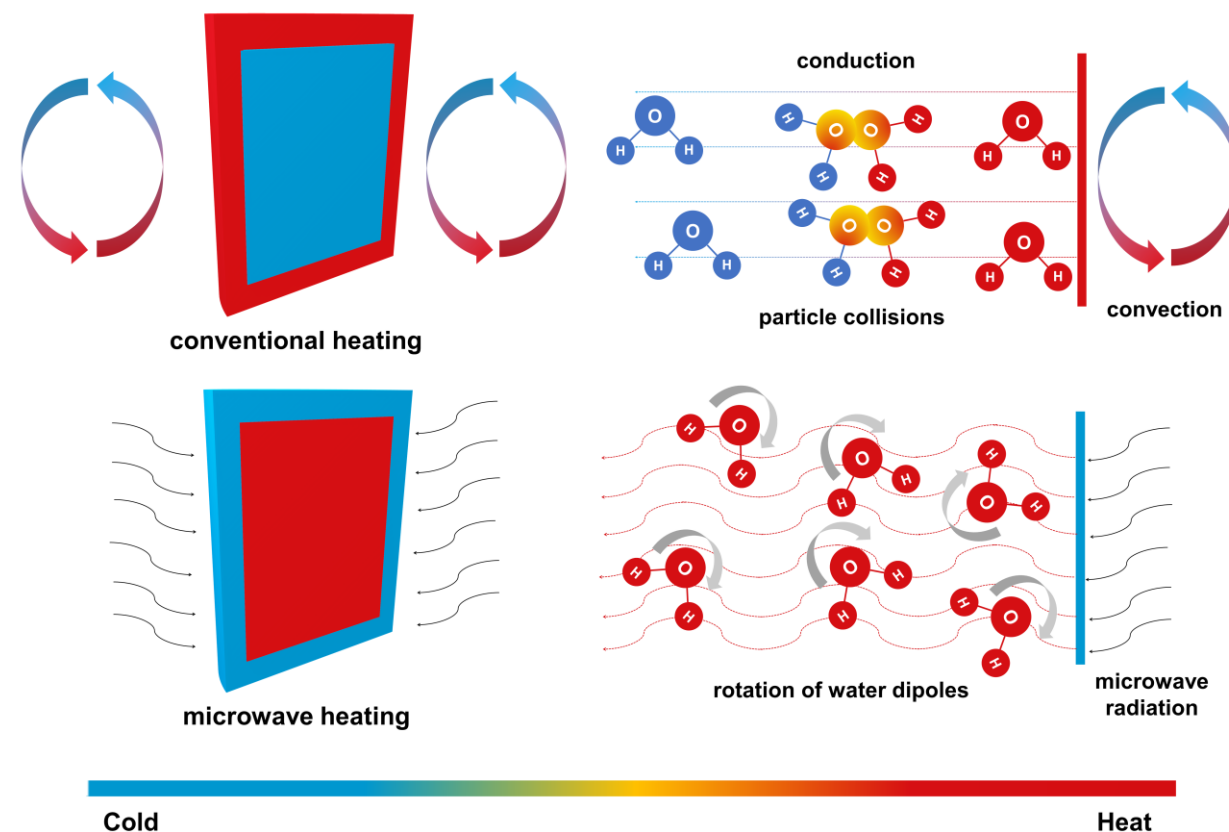

Kubiak, A.; Siwińska-Ciesielczyk, K.; Goscińska, J.; Dobrowolska, A.; Gabała, E.; Czaczyk, K.; Jesionowski, T. Hydrothermal-assisted synthesis of highly crystalline titania–copper oxide binary systems with enhanced antibacterial properties. *Mater. Sci. Eng. C* **2019**, 104, 109839.

Wojnarowicz, J.; Chudoba, T.; Lojkowski, W. A review of microwave synthesis of zinc oxide nanomaterials: Reactants, process parameters and morphologies. *Nanomaterials* **2020**, 10, 1086.

Roberts, B.A.; Strauss, C.R. Toward Rapid, “Green”, Predictable Microwave-Assisted Synthesis. *ChemInform* **2005**, 36, 653–661.

Aim of the work



Firstly, the application of the microwave approach to synthesize $\text{TiO}_2\text{-ZnO}$ oxide systems.

Next, the comprehensive physicochemical characterization will be carried out including the crystallinity and morphology.

One of the key objective will be the evaluation of the photocatalytic activity of the obtained materials in the phenol photodegradation process.

Finally, the synthesized $\text{TiO}_2\text{-ZnO}$ systems will be used as the electrode materials in the dye-sensitized solar cells.



Synthesis proces – I step (TiO₂)



- ✓ Since microwave radiation can also have a different effect on sequential processes, so that microwaves can effectively interact to a greater or lesser extent with each of the synthesis intermediates, a two-step method of synthesis was used.
- ✓ First, titanium dioxide was obtained, while in the second step, a two-component oxide system was formed.
- ✓ TiO₂ synthesis was started with the addition of up to 10% aq. TiCl₄ solution, 2 g polyvinylpyrrolidone. Then, an appropriate amount of 25% aqueous ammonia solution was dosed into the reaction mixture prepared in this way until the pH was 9.
- ✓ Finally, the obtained mixture was then transferred to microwave reactor and heated at 200 °C for 10 min at a power of 300 W.

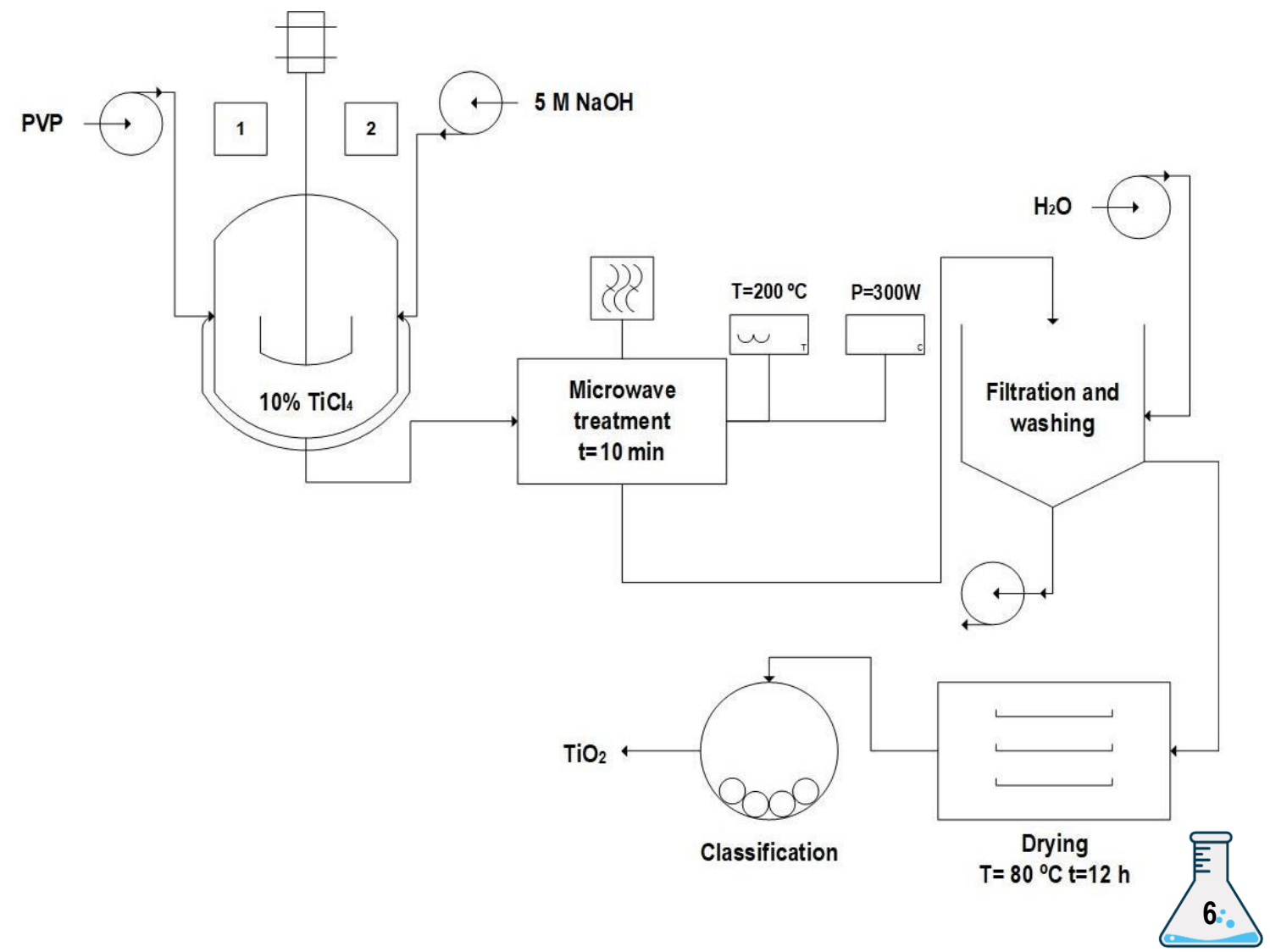

Synthesis proces – II step (TiO₂-ZnO)



- ✓ In 100 mL of a 5% aqueous solution of zinc acetate, 1 g of polyvinylpyrrolidone (PVP) was added.
- ✓ The received mixture was adjusted to pH 8 with used 1 M sodium hydroxide solution.
- ✓ The titania prepared in the first step was added as a suspension in water and next stirred for 30 min.
- ✓ Finally, the obtained mixture was subjected to microwave treatment at 150 °C for 10 min at a power of 300 W.
- ✓ Materials were obtained at the molar ratios TiO₂:ZnO= 9:1, 7:3, 5:5, 3:7, 1:9, being respectively labeled (9)TiO₂-(1)ZnO, (7)TiO₂-(3)ZnO, (5)TiO₂-(5)ZnO, (3)TiO₂-(7)ZnO and (1)TiO₂-(9)ZnO.
- ✓ Additionally, for comparison purposes, titanium dioxide and zinc oxide samples were obtained as reference samples.

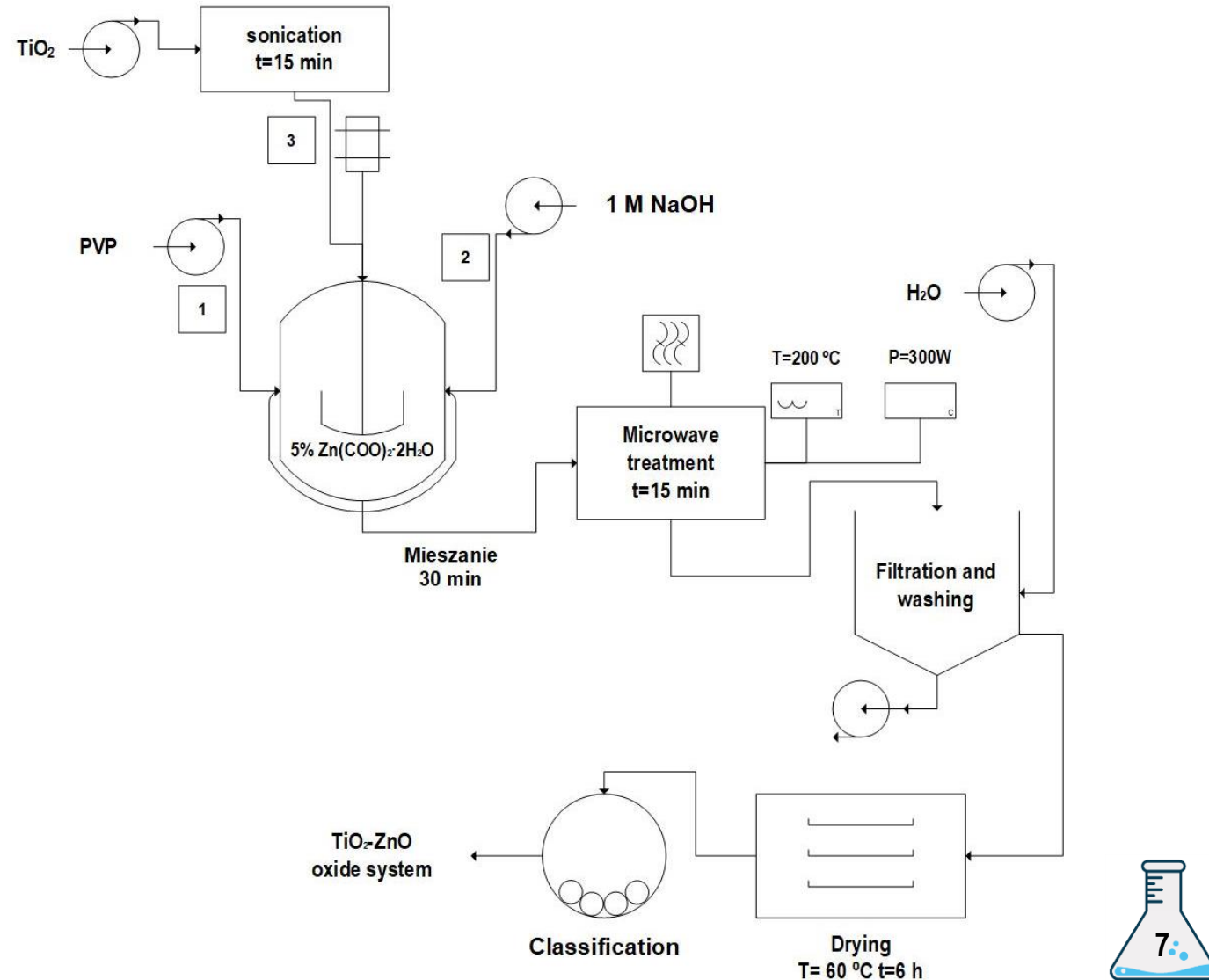

Physicochemical analysis

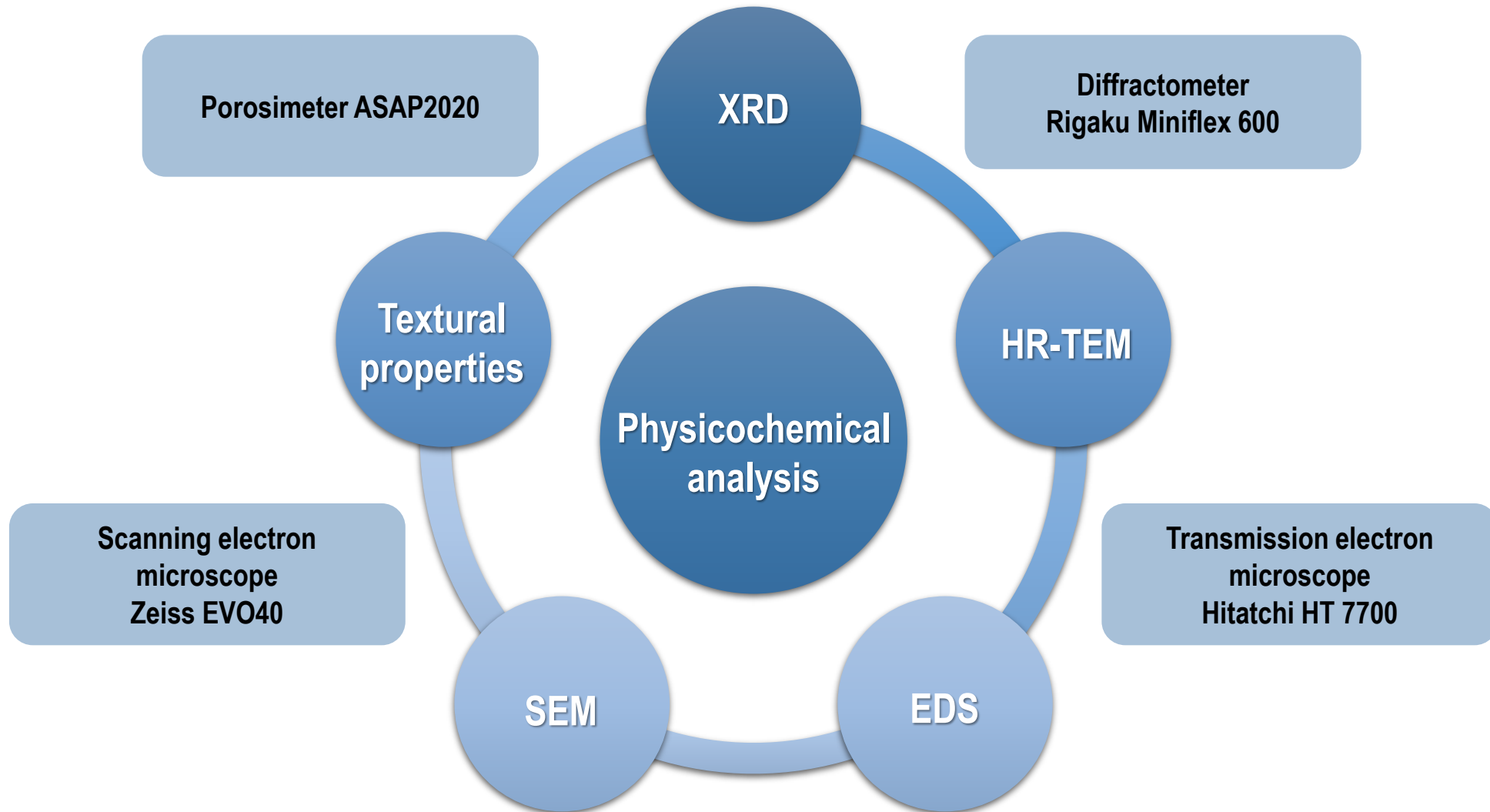

Results of SEM and TEM analysis

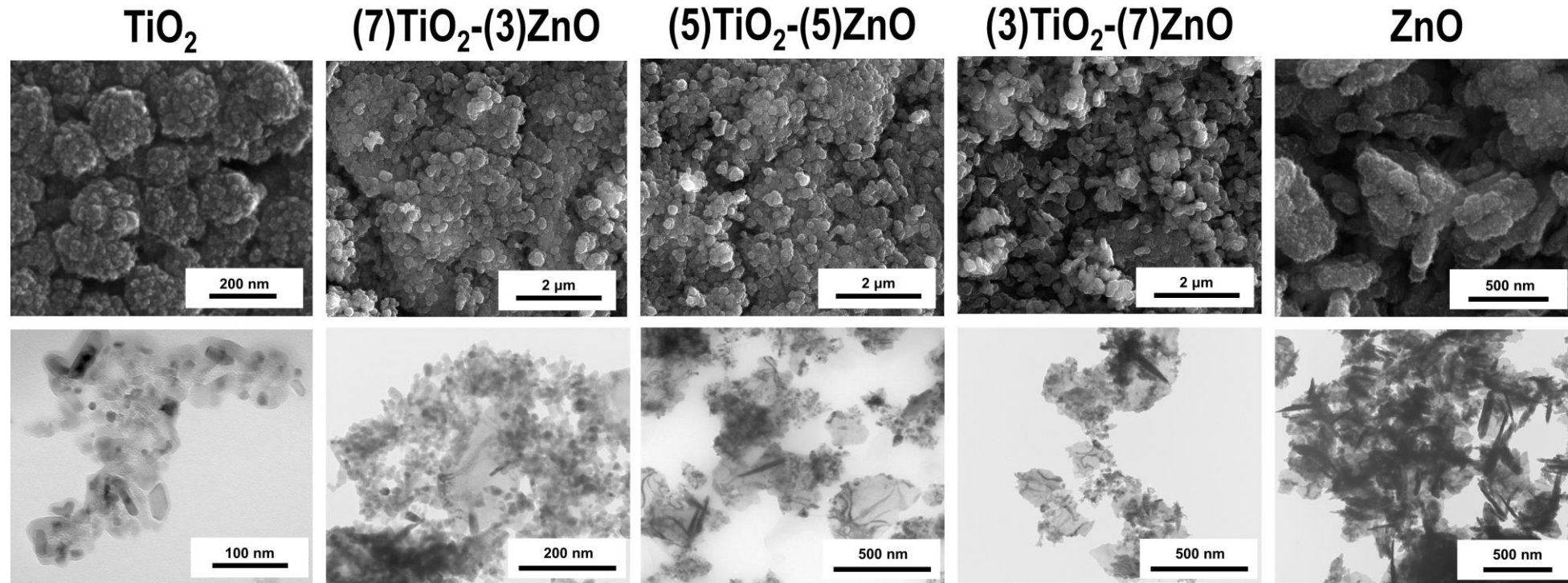

TiO_2 sample shows the presence of nanoparticles of various shapes, e.g. overlong (<50 nm) and octahedral (<25 nm)

The oxide systems are characterized by the presence of both TiO_2 nanoparticles and morphological forms corresponding to the ZnO phase. The occurrence of single ZnO nanostructures, which were, to some extent, covered with aggregated TiO_2 nanoparticles, was observed

The ZnO material, overlong particles (~400-500 nm) and nanosheets (<250 nm) were observed

Results of EDS mapping



- ✓ The obtained EDS maps of titanium and zinc in the analyzed materials showed a non-homogeneous distribution of titanium and zinc.
- ✓ It was observed that TiO_2 occurs in the form of nanoparticle aggregates, while ZnO in the form of overlong particles and nano-sheets.
- ✓ Analyzing the obtained results of EDS mapping, attention should be paid on to the similar distribution of TiO_2 and ZnO in the analyzed samples, which indicates that the aggregates of titanium dioxide nanoparticles are on the nanosheets ZnO structures.

STEM image

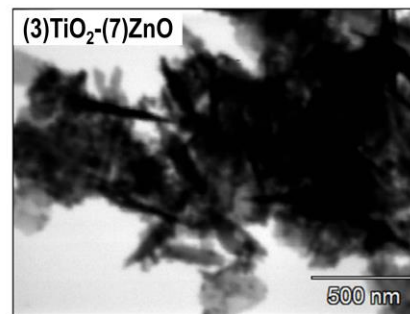
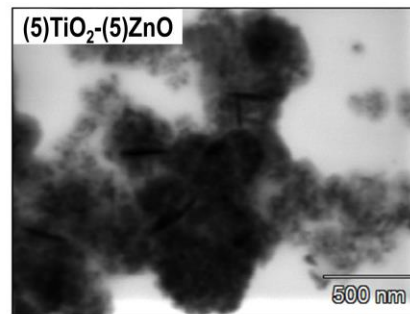
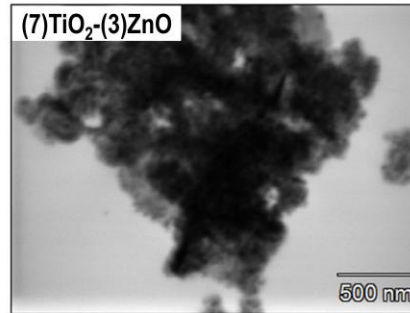

EDS mapping for Ti

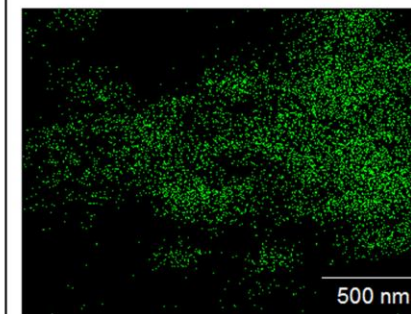
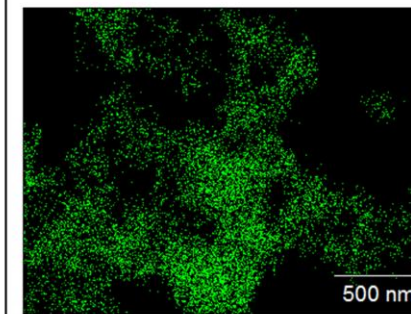
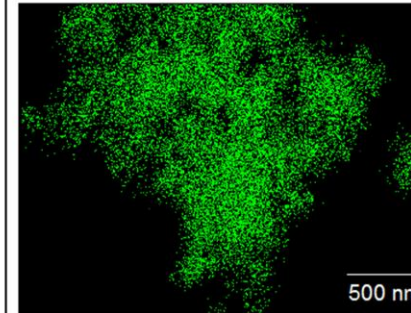

EDS mapping for Zn

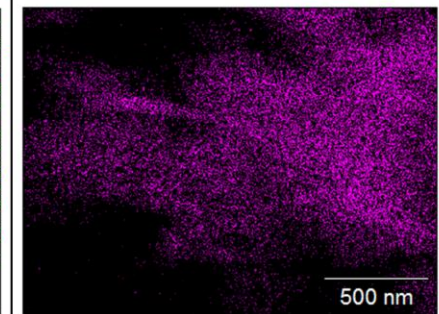
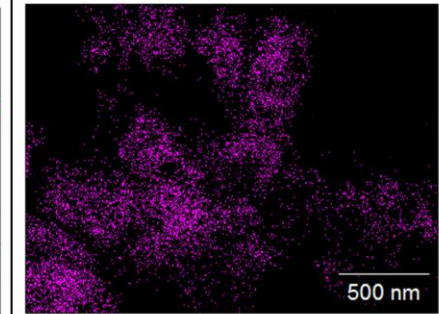
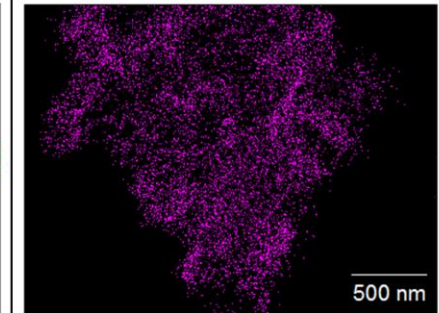

Results of HR-TEM analysis



- ✓ On the basis of the obtained HRTEM results, it was shown that for the oxide systems formed at the molar ratio of $\text{TiO}_2:\text{ZnO}=7:3$, $5:5$ and $3:7$, crystallographic spacings of 0.35 nm and 0.26 nm corresponding to the (101) anatase and (002) wurtzite planes were observed.
- ✓ In the case of the material (7) TiO_2 -(3) ZnO , crystallographic distances of 0.24 nm characteristic for the anatase plane (004) were also observed. Changes in the crystallinity of individual materials are also observed in the presented FFT images.
- ✓ Additionally, regardless of the analyzed material, the presented HRTEM measurements confirm the high crystallinity of the obtained materials.
- ✓ Finally, on the basis of the EDS point measurement, it was confirmed that the obtained experimental data (Zn and Ti ratios) are close to the assumed theoretical values of $\text{TiO}_2:\text{ZnO}$ molar ratios.

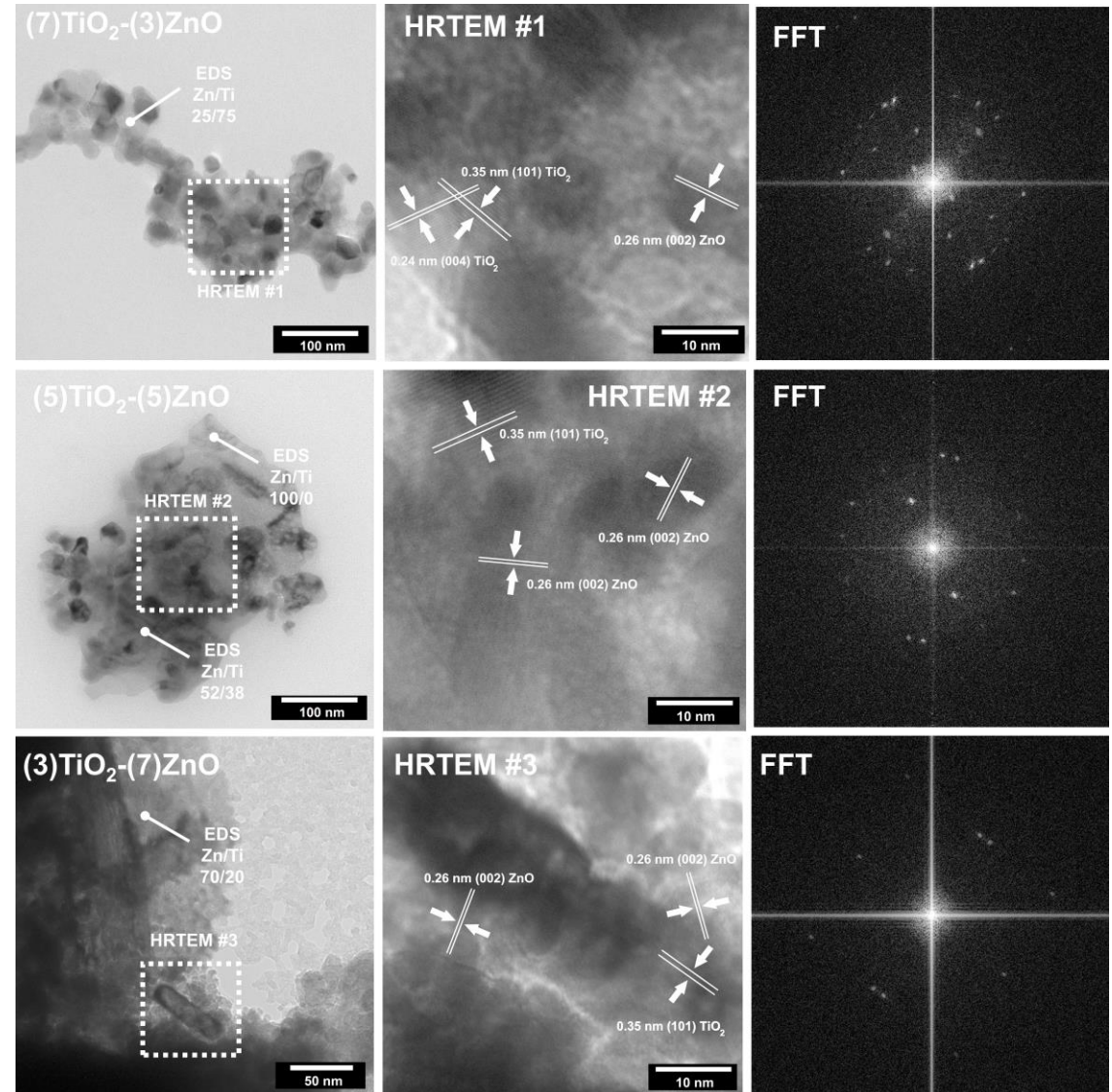

Results of XRD analysis



For the titanium dioxide sample, the diffraction peaks characteristic of the anatase crystal structure (card no. 9009086) were observed.

In case the reference ZnO sample, diffraction reflections corresponding to the structure of the wurtzite (card no. 2300112) were noted.

Based on the crystallography results for two-component materials, it was shown that regardless of the molar ratio of TiO₂:ZnO, diffraction reflections corresponding to both anatase and wurtzite structures were observed.

It was found that for the reference TiO₂ and ZnO samples, the crystallite size is 14.6 nm and 25.7 nm, respectively. While, for the oxide systems, similar values of the crystallite size are observed as for the samples mentioned above.

Sample	Phase composition (%)		Crystallinity size (nm)	
	anatase	wurtzite	anatase	wurtzite
TiO ₂	100(1)	–	14.6 (±0.1)	–
(9)TiO ₂ -(1)ZnO	92(2)	8(1)	16.5 (±0.1)	20.7 (±0.8)
(7)TiO ₂ -(3)ZnO	74(1)	26(1)	15.7 (±0.1)	23.1 (±0.4)
(5)TiO ₂ -(5)ZnO	54(3)	46(2)	15.8 (±0.1)	25.2 (±0.2)
(3)TiO ₂ -(7)ZnO	34(1)	66(2)	15.7 (±0.2)	25.2 (±0.1)
(1)TiO ₂ -(9)ZnO	16(2)	84(1)	15.3 (±0.1)	25.3 (±0.2)
ZnO	–	100(3)	–	25.7 (±0.1)

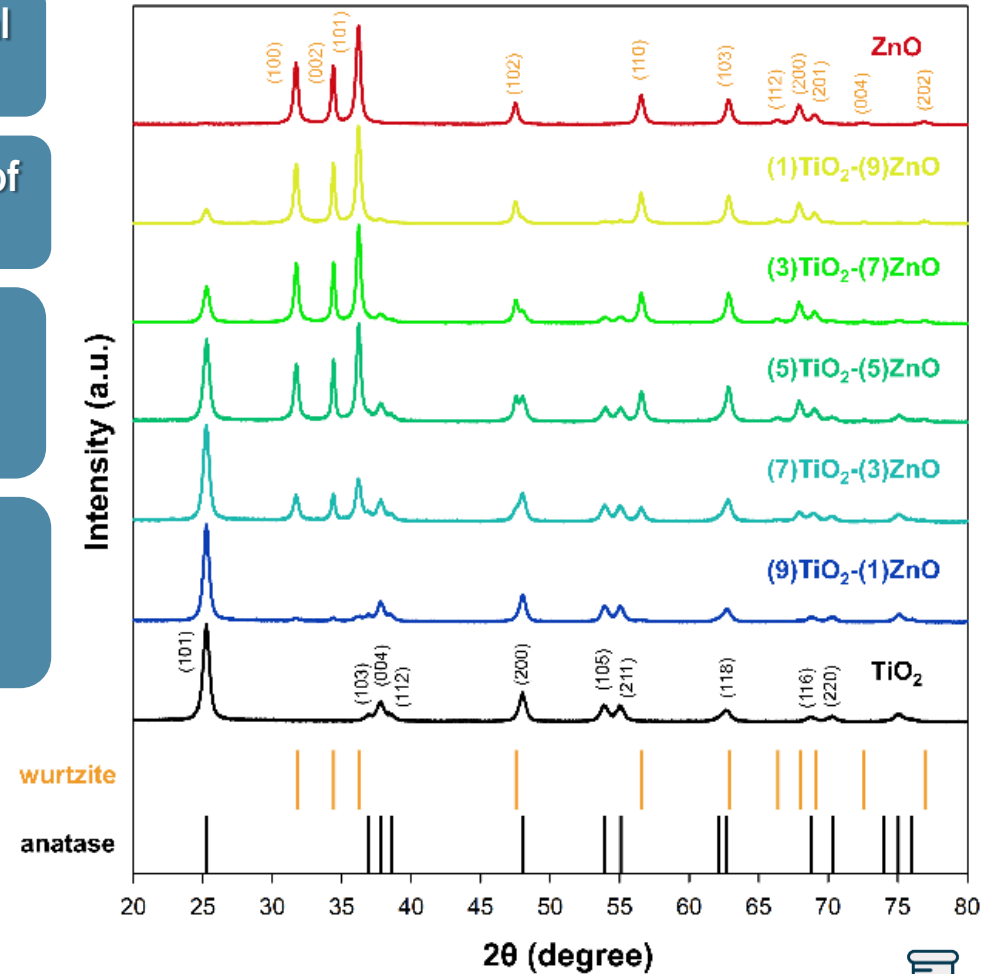

Results of low-temperature N₂ adsorption



Based on the obtained nitrogen sorption isotherms, it was shown that the synthesized oxide materials, either the reference samples and the TiO₂-ZnO oxide systems, are characterized by the isotherm type IV with the H3 hysteresis loop.

The H3 type hysteresis loop indicates that the analyzed material consists of aggregates of plaque-like particles, which create slit pores.

Among all synthesized materials, the reference material TiO₂ had the highest specific surface area, on the other hand the reference ZnO sample was characterized by the lowest parameters. While the parameters of the porous structure determined for the TiO₂-ZnO oxide systems were between the values mentioned above of the specific surface area and the volume and average pore diameter.

Sample	A _{BET} (m ² /g)	V _p (cm ³ /g)	S _p (nm)
TiO ₂	73	0.75	37.9
(9)TiO ₂ -(1)ZnO	69	0.52	27.3
(7)TiO ₂ -(3)ZnO	62	0.41	21.8
(5)TiO ₂ -(5)ZnO	50	0.32	20.5
(3)TiO ₂ -(7)ZnO	39	0.22	20.1
(1)TiO ₂ -(9)ZnO	29	0.15	18.5
ZnO	22	0.11	17.3

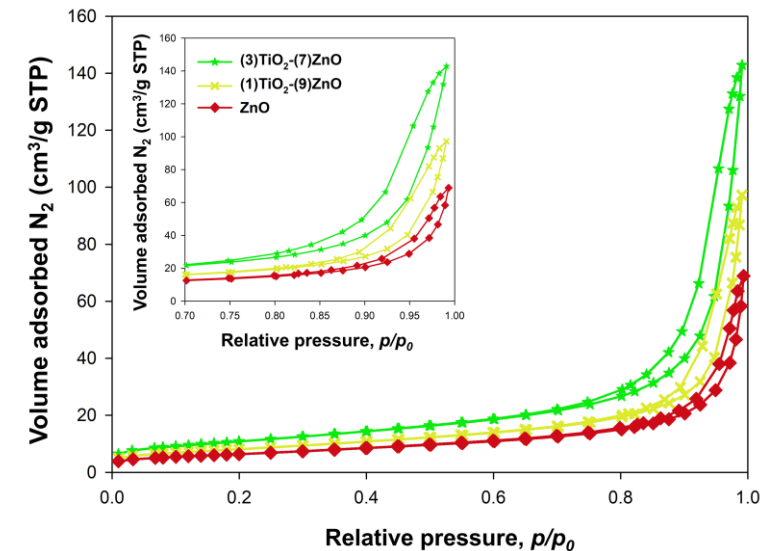
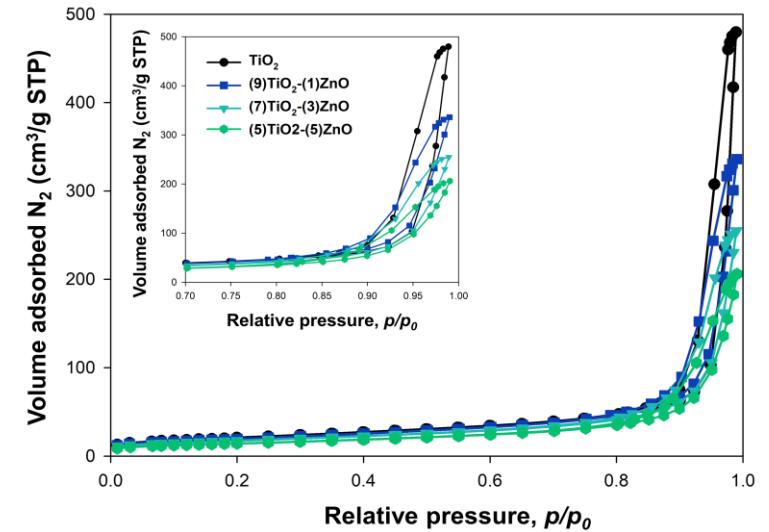

Photoactivity test



It was shown that the TiO_2 sample was characterized by both high degradation efficiency (90%) and mineralization (75%) of phenol. Whereas for the reference ZnO sample the degradation and mineralization efficiency was determined at the level of – 60% and 50%, respectively.

It was shown that the obtained oxide systems are characterized by high efficiency of phenol degradation and mineralization. The highest efficiency of phenol decomposition was noted for (9) TiO_2 -(1)ZnO and (7) TiO_2 -(3)ZnO systems. For this material, the yield of degradation and mineralization was higher than for the reference samples.

The decrease in photocatalytic activity for the remaining materials is probably related to the rapid electron-hole recombination as well as the increase in ZnO content, which may adversely affect the absorption of radiation photons.

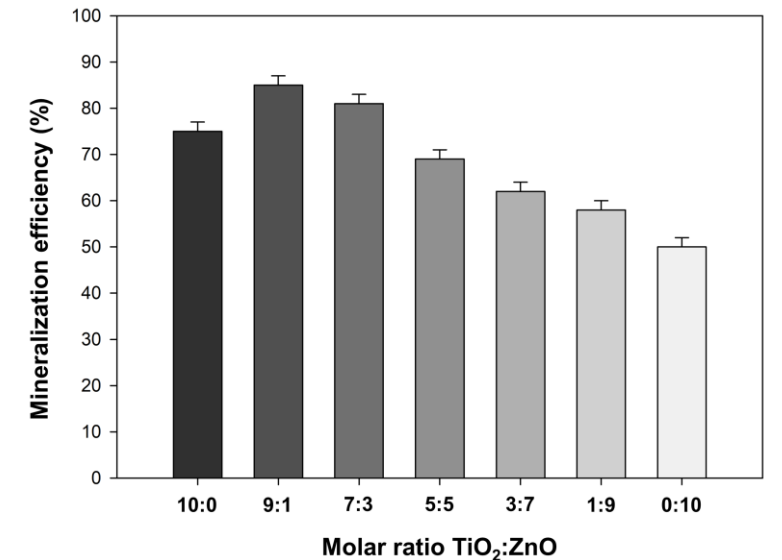
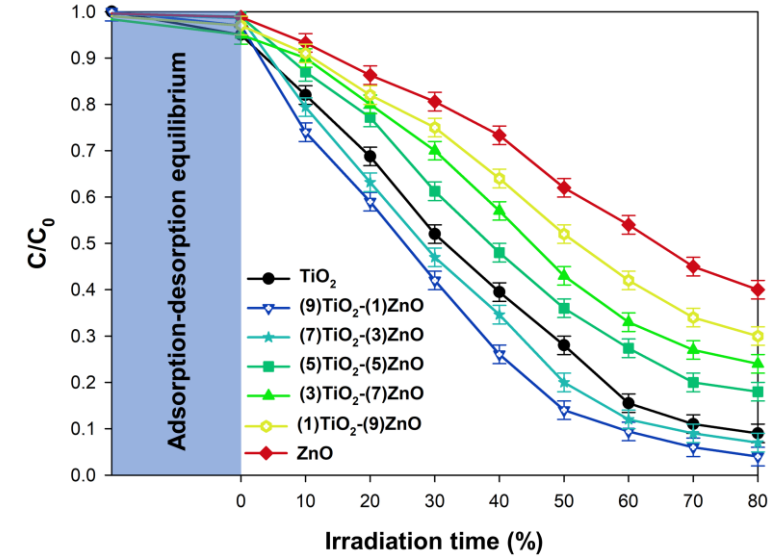

Proposed mechanism of photodegradation process



- ✓ As a possible mechanism of the process of the photocatalytic degradation of phenol, the free radical mechanism based on a type II heterojunction was indicated.
- ✓ The proposed mechanism is most preferred from the standpoint of the process efficiency of the photocatalytic degradation of organic pollutants. This is due to the favorable energy gradient at the interface, which allows for effective separation (separation) of the charge carriers.
- ✓ Photogenerated electrons in a semiconductor with a higher conduction band energy (ZnO) migrate to the conduction band of a semiconductor with a lower conduction band energy (TiO₂). In contrast, the photogenerated holes in the higher-energy valence (TiO₂) semiconductor are transferred towards the valence band of the lower-energy (ZnO) semiconductor.

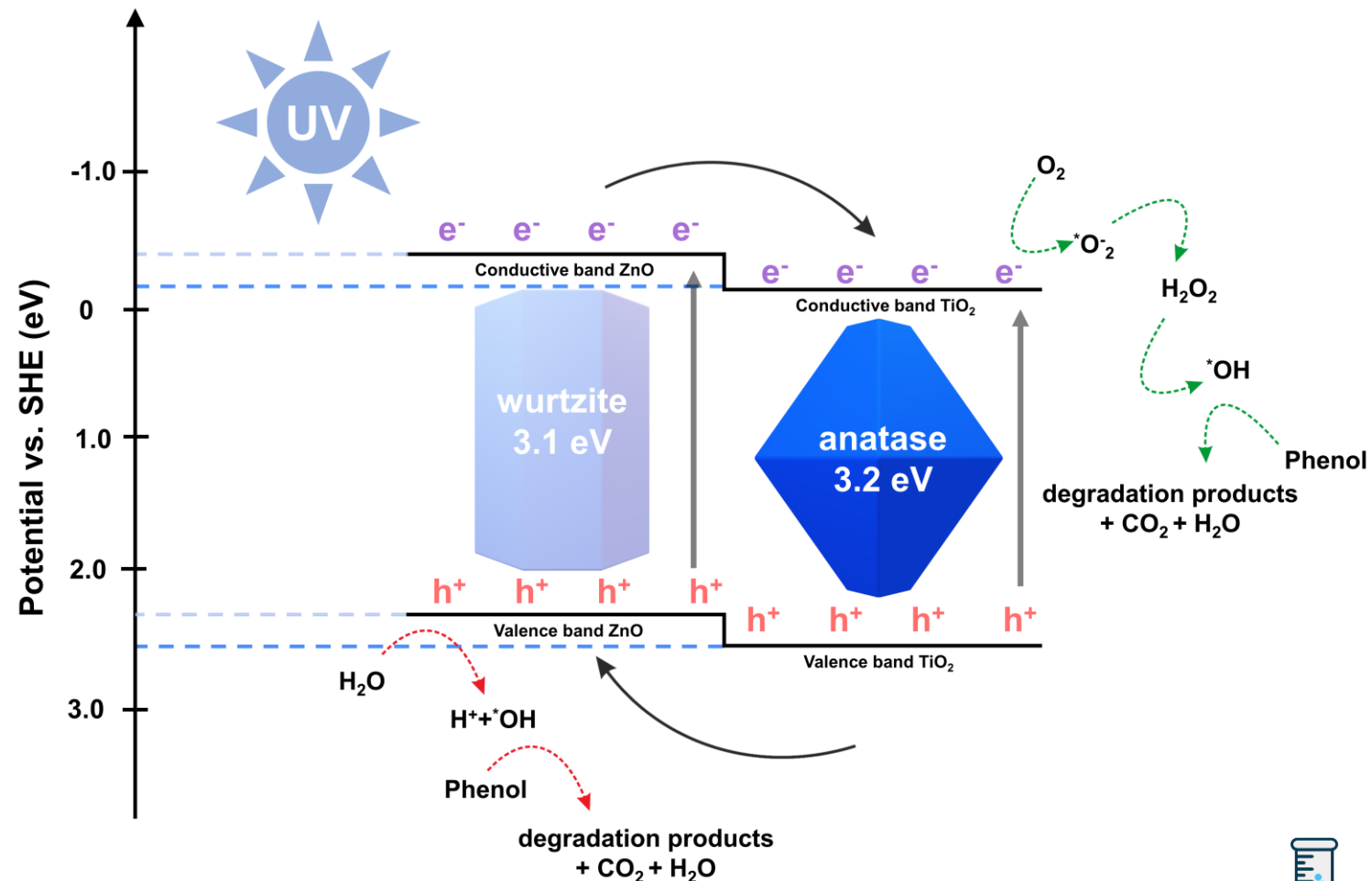

Photovoltaic properties



Tested cells showed variable photovoltaic activity, closely dependent on the electrode material used. It can be observed that the highest photovoltaic conversion efficiency (η) was demonstrated by the cell utilizing (9)TiO₂-(1)ZnO material.

It may be observed that the main reason for the reduction of the efficiency of the cells is the reduction of the photocurrent density (JSC) while maintaining high values of the open circuit potential (VOC) and fill factor (FF). This situation can be attributed to the effects associated with an increase in the tendency to recombination of excited electrons, along with an increase in the ZnO content.

The existence of the energy difference between the conduction bands of TiO₂ and ZnO and its influence on the VOC value may also be the most likely a reason for the behavior of the cell based on the (9)TiO₂-(1)ZnO material. However, the increased open circuit potential causes an increase in the efficiency of the entire system.

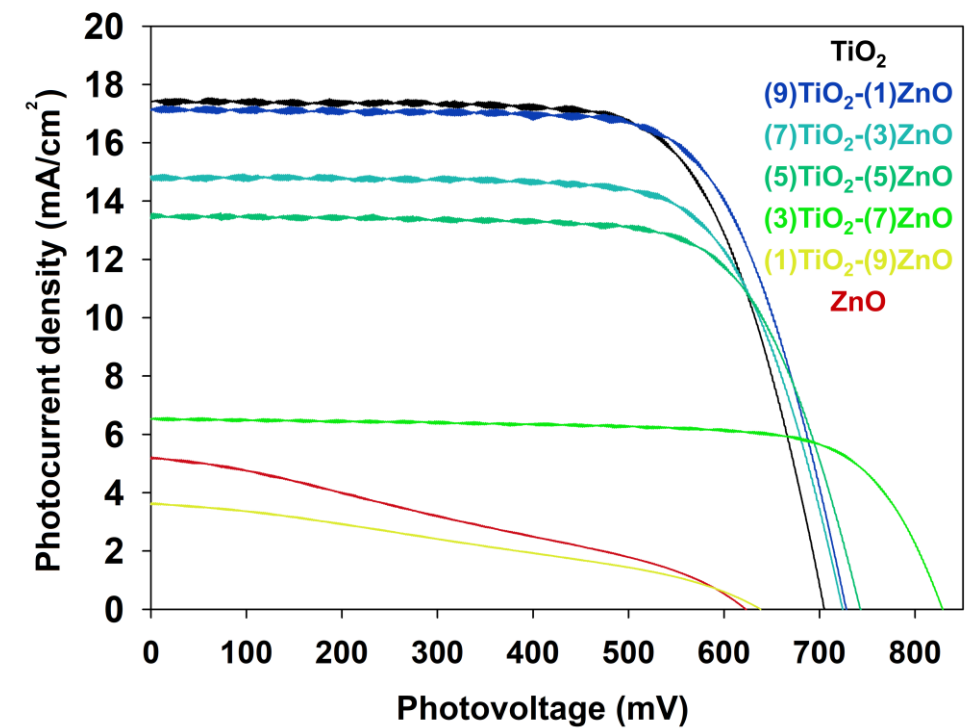

Sample	VOC (mV)	JSC (mA×cm ⁻²)	FF (%)	η (%)
TiO ₂	705	17.5	69.9	8.65
(9)TiO ₂ -(1)ZnO	728	17.3	70.4	8.84
(7)TiO ₂ -(3)ZnO	724	14.9	71.2	7.69
(5)TiO ₂ -(5)ZnO	743	13.6	70.8	7.15
(3)TiO ₂ -(7)ZnO	829	6,57	73.4	4.00
(1)TiO ₂ -(9)ZnO	638	3,65	33.4	0.78
ZnO	623	5.22	31.0	1.01

Photovoltaic properties



- ✓ The R1 and R2 values, mainly dependent on the parameters of the measuring system used, and the resistance of the counter electrode used to build the cells, respectively. Based on the results it is visible that they do not differ significantly from each other, do not depend on the semiconductor materials used and do not have a more significant impact on differences in their efficiency in the devices discussed.
- ✓ The R3 value, representing the semiconductor/dye/electrolyte interface resistance, is closely related to the semiconductor material used. Observation of the R3 value allows explaining the rapid decrease in the activity of systems, which, apart from the recombination effects, is caused by a sharp increase in the resistance of the semiconductor layer, which significantly impedes transport of the injected electrons inside the cells, translating into their low efficiency.

Sample	R ₁ (Ω)	R ₂ (Ω)	R ₃ (Ω)	τ (ms)	N _{dye} (nmol/cm ²)
TiO ₂	18.7	6.4	27.5	5.1	189
(9)TiO ₂ -(1)ZnO	14.1	5.8	26.8	6.4	200
(7)TiO ₂ -(3)ZnO	16.7	7.2	24.4	4.1	189
(5)TiO ₂ -(5)ZnO	20.7	7.6	23.4	3.2	180
(3)TiO ₂ -(7)ZnO	15.7	10.1	46.8	2.5	255
(1)TiO ₂ -(9)ZnO	19.8	12.7	309.7	20.0	245
ZnO	12.9	15.6	310.2	25.1	215

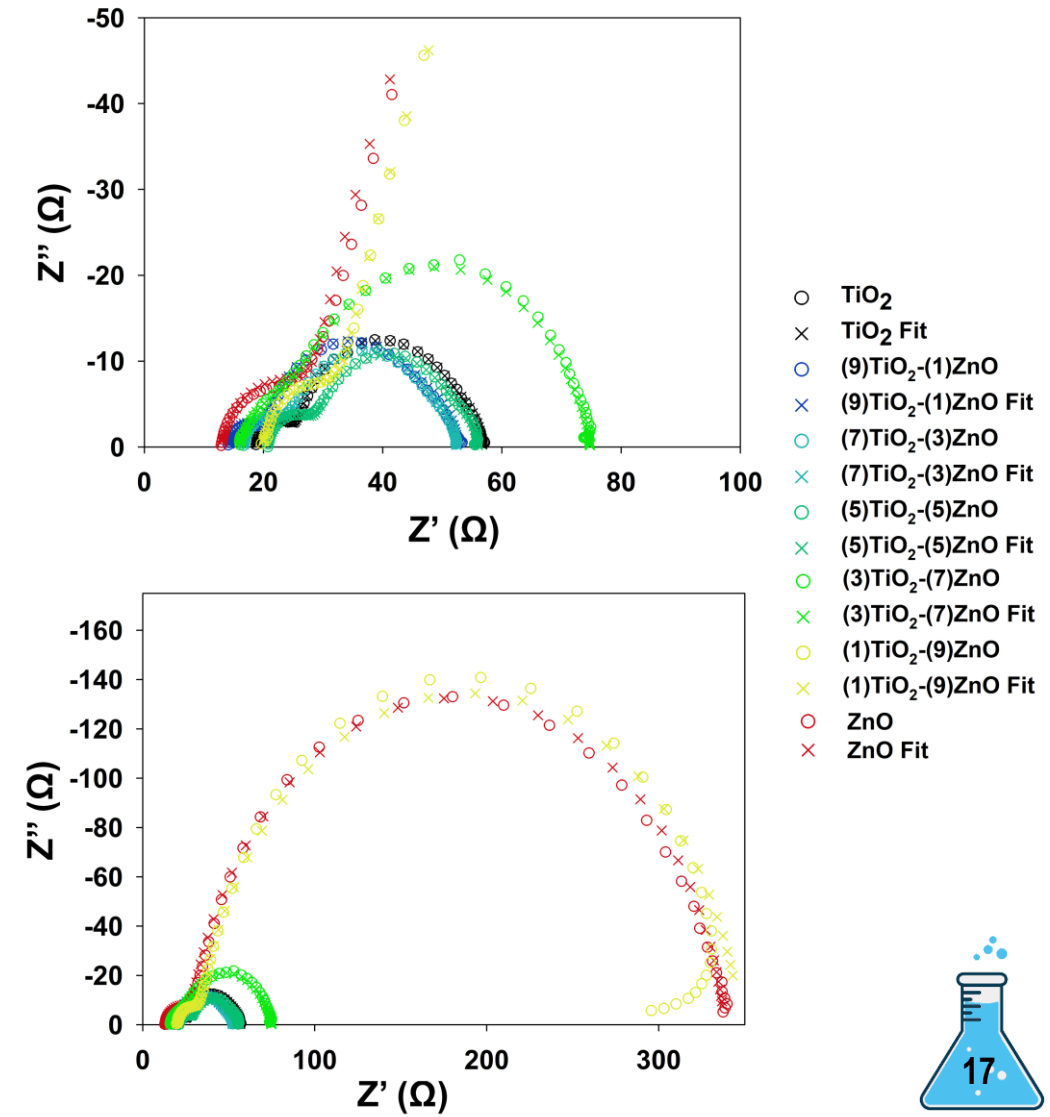

Conclusions



First of all, the primary goal of this research was to apply the microwave synthesis to obtain titanium dioxide-zinc oxide systems.

Based on the XRD and HRTEM results obtained for the analyzed materials, the presence of anatase and wurtzite crystalline structures was confirmed.

It was found that the synthesized systems are characterized by the presence of morphological forms corresponding to titanium dioxide (overlong and octahedral) and zinc oxide (nanosheets).

Based on the photo-oxidation tests it was shown that the binary oxide materials demonstrate high photocatalytic activity in the decomposition of phenol – 95% after 80 min of irradiation

The obtained two-component systems were tested in DSSC with satisfactory results. The best photovoltaic parameters have been found in the case of the (9)TiO₂-(1)ZnO material, which was characterized by an efficiency of 8.84%.





Poznan University of Technology
Faculty of Chemical Technology
Institute of Technology and Engineering Chemistry



**Thank you for
your attention**



MSc. Adam Kubiak
adam.l.kubiak@doctorate.put.poznan.pl