

Proceedings of the 7th International Electronic Conference on Sensors Networks, 15 – 30 November, 2020, Sensors MDPI, Basel, Switzerland.

A CONFERENCE PAPER PRESENTATION

By:



ROTICH PHILEMON, HILARY RAMBO AND ANNA GEOFREY

SCHOOL OF COMPUTATIONAL AND COMMUNICATION SCIENCE AND ENGINEERING (COCSE), NELSON MANDELA AFRICAN INSTITUTION OF SCIENCE AND TECHNOLOGY (NM-AIST) ARUSHA, TANZANIA.

Paper Title:

Early Fire Detection System in Tanzania Markets, A Case Study of the Kilombero Market

P.Rotich, H.Rambo, A.Geofrey and Dr. A.Sam, NM-AIST, Arusha, Tanzania.

Proceedings of the 7th International Electronic Conference on Sensors Networks, 15 – 30 November, 2020, Sensors MDPI, Basel, Switzerland.

Presentation Outline

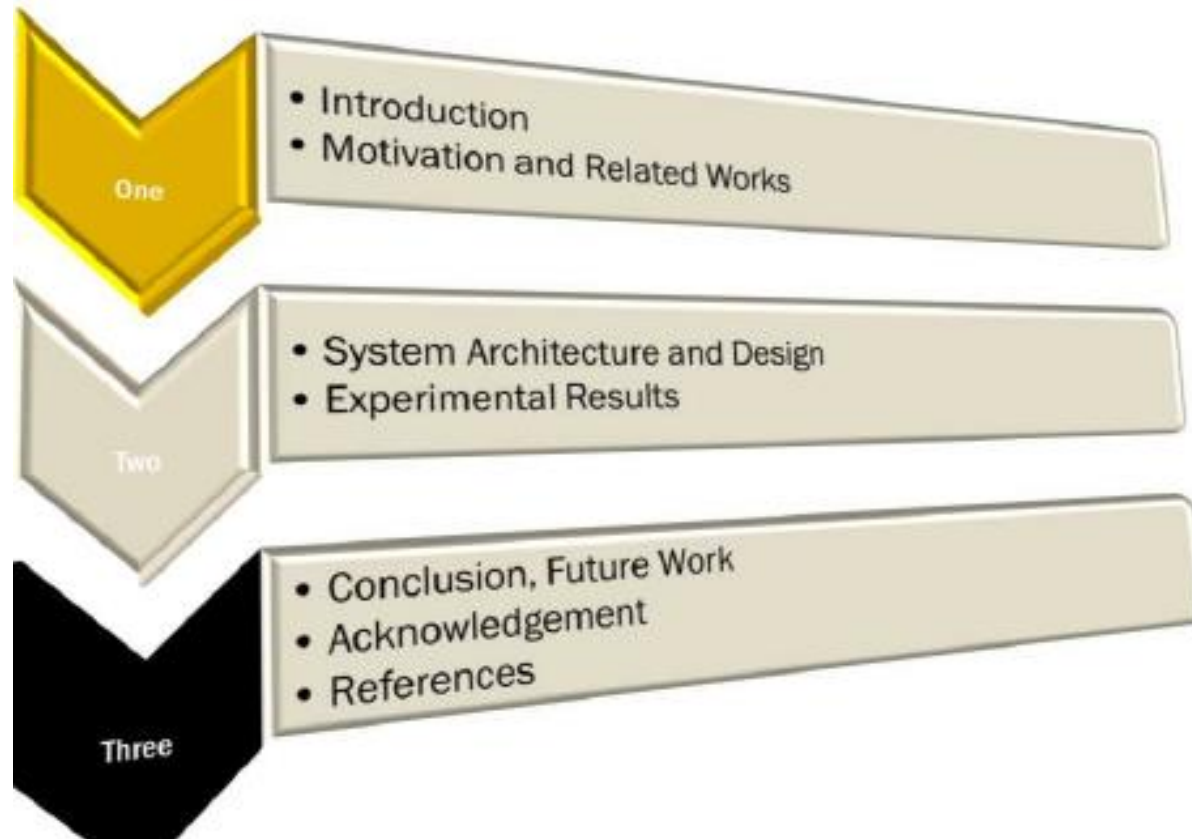

P.Rotich, H.Rambo, A.Geofrey and Dr. A.Sam, NM-AIST, Arusha, Tanzania

Introduction

- This research paper presents the design, implementation and development of a real-time notification system based on wireless sensor network. The developed system could give real-time monitoring through real-time notification of fire outbreak reducing the chance of fire spreading fast hence saving on life and property.
- This system act as an early warning system where an alert are directly sent to the market security guard and fire rescue team at its initial stage. This is achieved using arduino microcontroller, Raspberry Pi , XBee Module and temperature sensor , flame sensor and carbon monoxide sensors.

Proceedings of the 7th International Electronic Conference on Sensors Networks, 15 – 30 November, 2020, Sensors MDPI, Basel, Switzerland.

Motivation and Related Work

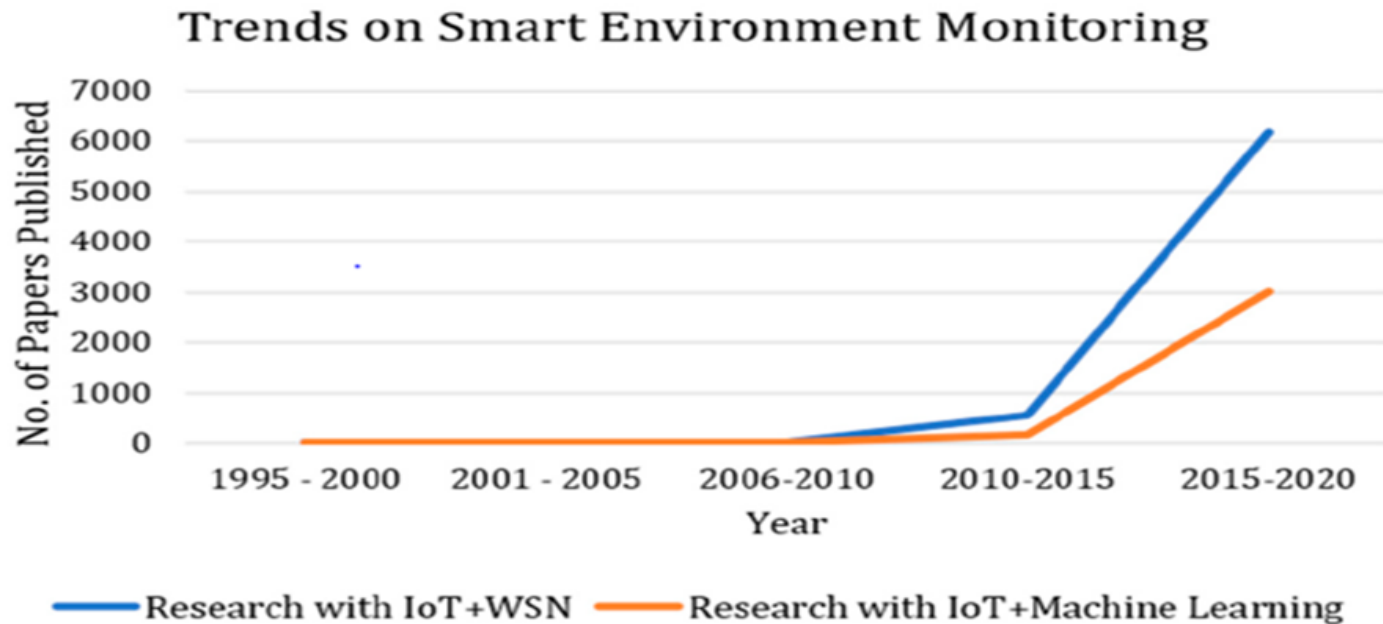

Figure 1: Trends on Smart Environment Monitoring (Source: An IoT sensor and scenario survey for data researchers, Feb, 2019)

P.Rotich, H.Rambo, A.Geofrey and Dr. A.Sam, NM-AIST, Arusha, Tanzania

Proceedings of the 7th International Electronic Conference on Sensors Networks, 15 – 30 November, 2020, Sensors MDPI, Basel, Switzerland.

Comparison of Some Communication Technologies Related to IoT

Standard	Bluetooth	Bluetooth 4.0 LE	ZigBee	Wi-Fi	6LoWPAN	RF-Link	Z wave
IEEE Spec.	IEEE 502.15.1	IEEE 502.15.4	IEEE 502.15.4	IEEE 502.11 a/b/g/n	IEEE 502.15.4 2006	C 95.1 2005	Z wave alliance
Topology	Star	Star	Mesh, Star, Tree	Star	Mesh, Star	-	Mesh
Bandwidth	1 Mbps	1 Mbps	250 Kbps	Up to 54Mbps	250 Kbps	18 MHz	900 MHz
Power Consumption	Very low	Very low	Very low	Low	Very low	Very low	Very low
Max Data rate (Mbit/s)	0.72	5 to 10 m	0.25	54	800 m sub GHz	1	9600 bits or 40 Kbits
Range	< 30 m	5 to 10 m	10 to 300 m	4 to 20 m	800 m sub GHz	< 3 m	30 m
Spectrum	2.4 GHz	2.4 GHz	2.4 GHz	2.4 - 5 GHz	2.4 GHz	2.4 GHz	2.4 GHz
Channel Bandwidth	1 MHz	2400 to 2480 MHz	2 MHz	22 MHz	868, 902, 2400 MHz	-	868 MHz

Source: IEEE Communications Magazine, A Survey on the Roles of Communication Technologies in IoT-based Personalized Healthcare Applications

P.Rotich, H.Rambo, A.Geofrey and Dr. A.Sam, NM-AIST, Arusha, Tanzania

Proceedings of the 7th International Electronic Conference on Sensors Networks, 15 – 30 November, 2020, Sensors MDPI, Basel, Switzerland.

Materials and Methods

System Design

- The system design of the project is composed of three subsystems that are integrated to provide real-time fire detection. The subsystems are the sensing system (sensors), Data processing System (Sink Node-Raspberry Pi), Cloud server (Thing Speak) and Mobile Application.

P.Rotich, H.Rambo, A.Geofrey and Dr. A.Sam, NM-AIST, Arusha, Tanzania

System Architecture and Design

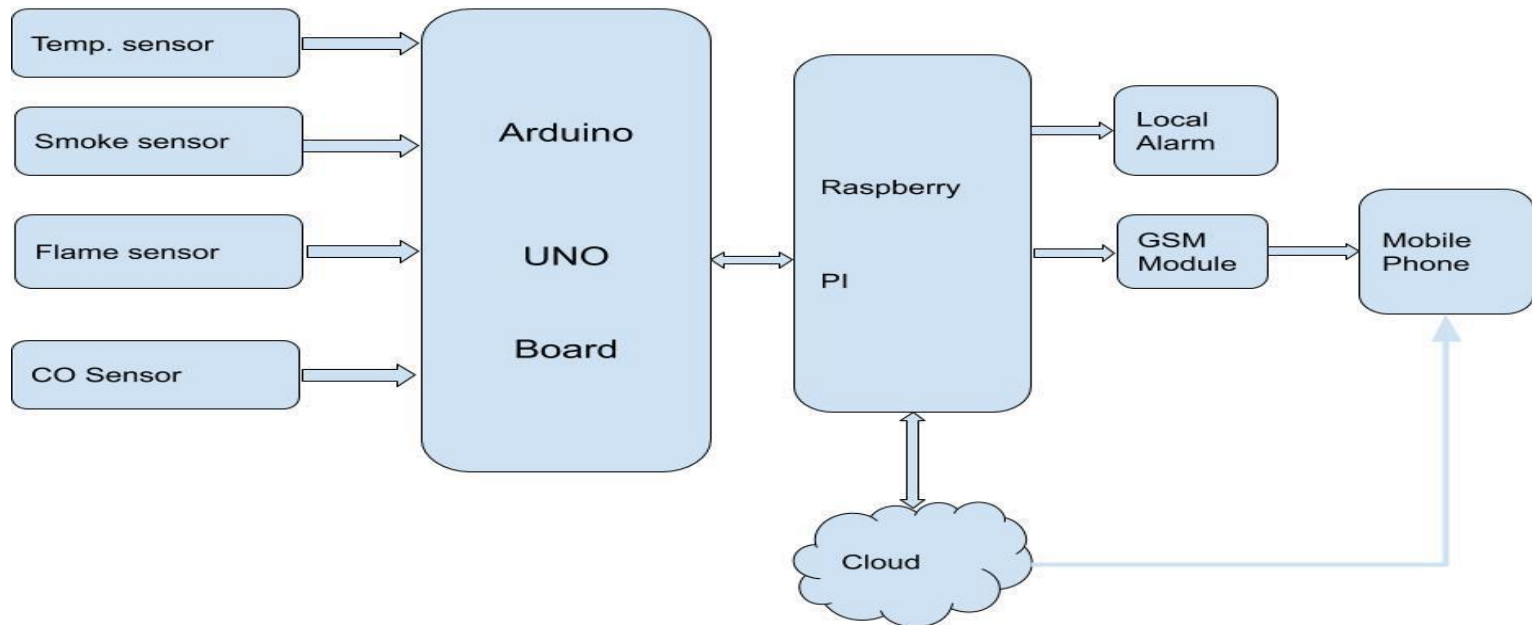

Proceedings of the 7th International Electronic Conference on Sensors Networks, 15 – 30 November, 2020, Sensors MDPI, Basel, Switzerland.

Sensing Subsystem

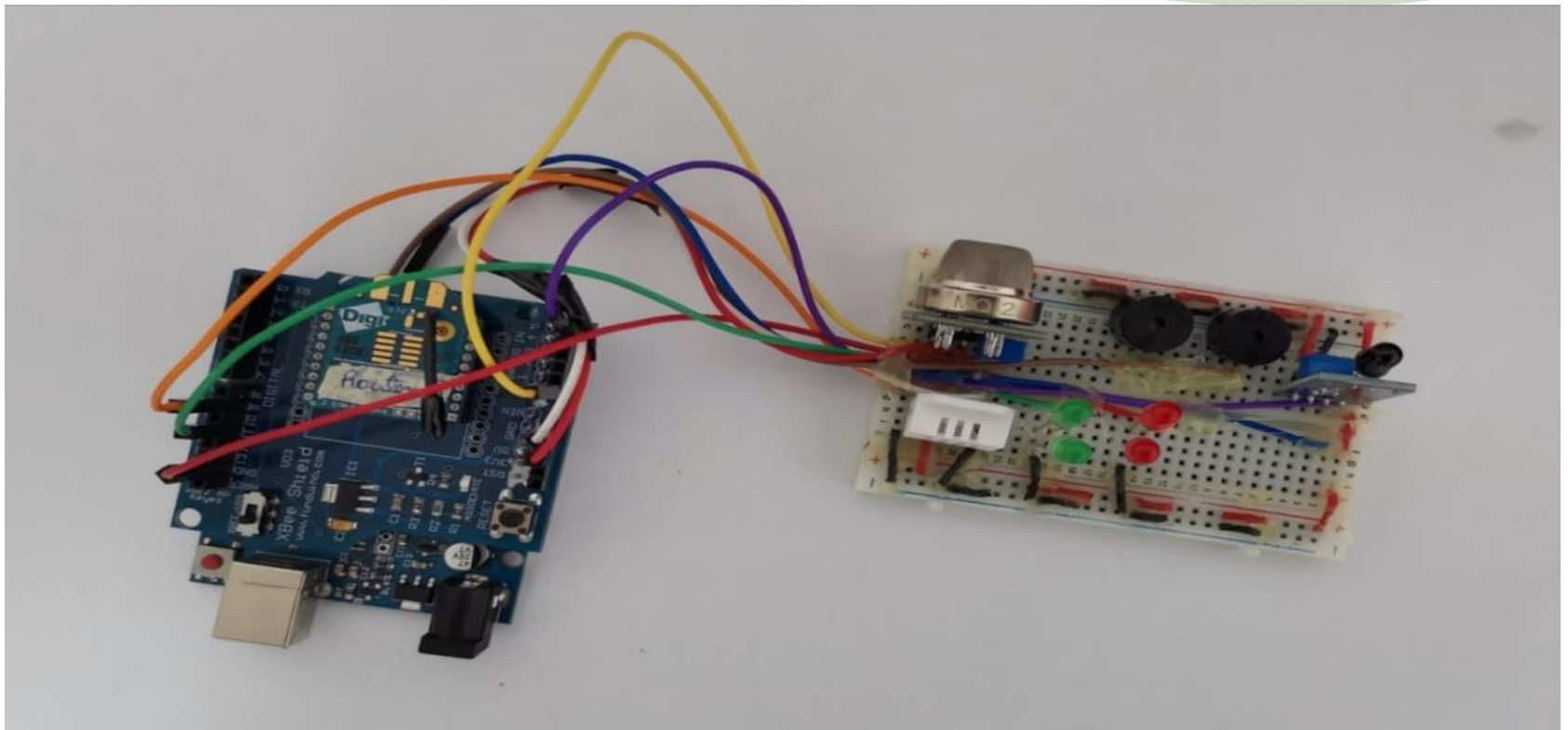

P.Rotich, H.Rambo, A.Geofrey and Dr. A.Sam, NM-AIST, Arusha, Tanzania

Proceedings of the 7th International Electronic Conference on Sensors Networks, 15 – 30 November, 2020, Sensors MDPI, Basel, Switzerland.

Sensing Subsystem Schematic

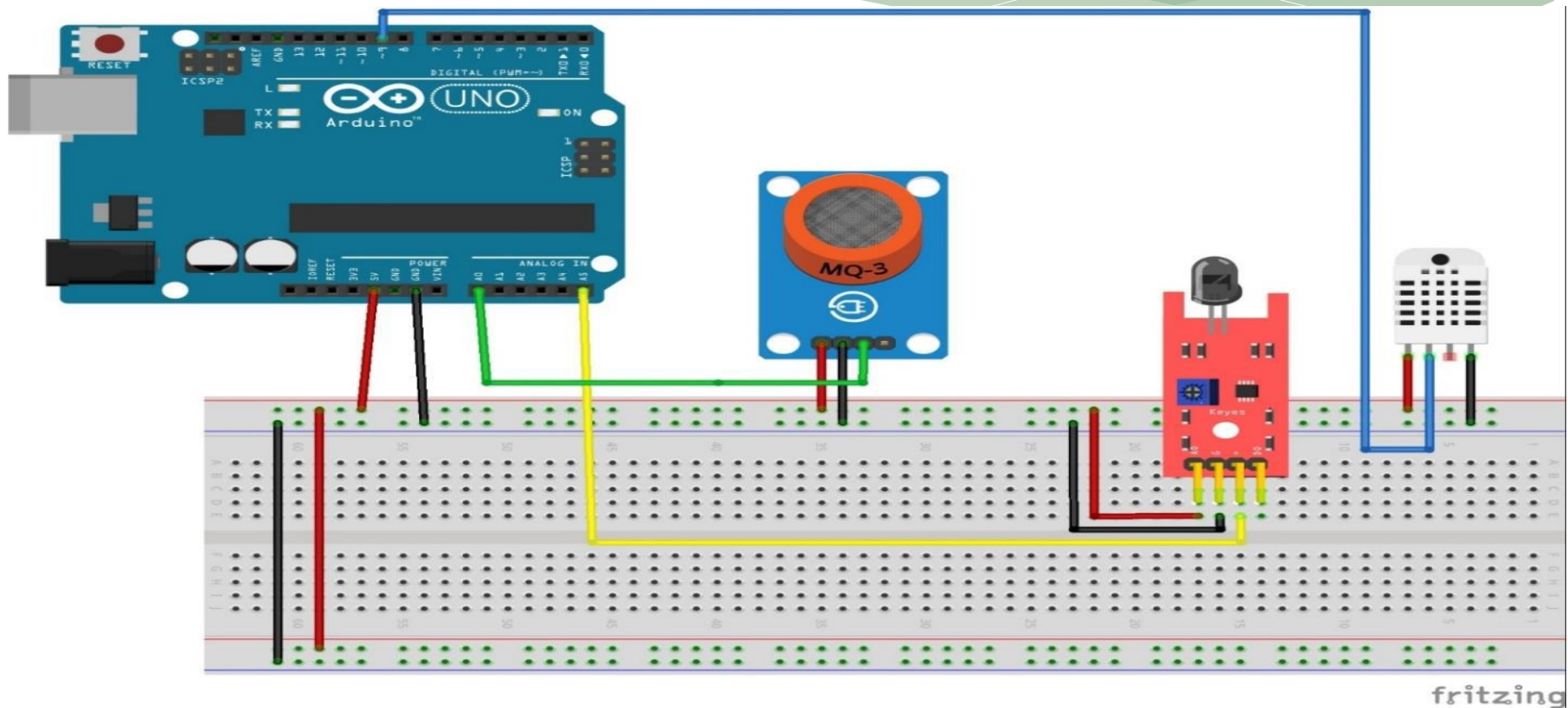

P.Rotich, H.Rambo, A.Geofrey and Dr. A.Sam, NM-AIST, Arusha, Tanzania

Proceedings of the 7th International Electronic Conference on Sensors Networks, 15 – 30 November, 2020, Sensors MDPI, Basel, Switzerland.

Data processing subsystem

Results

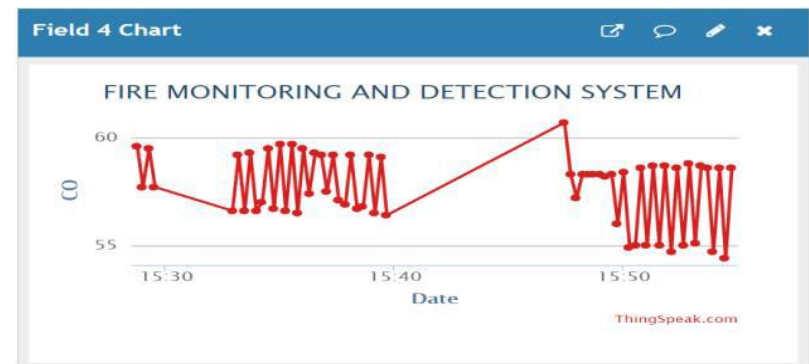
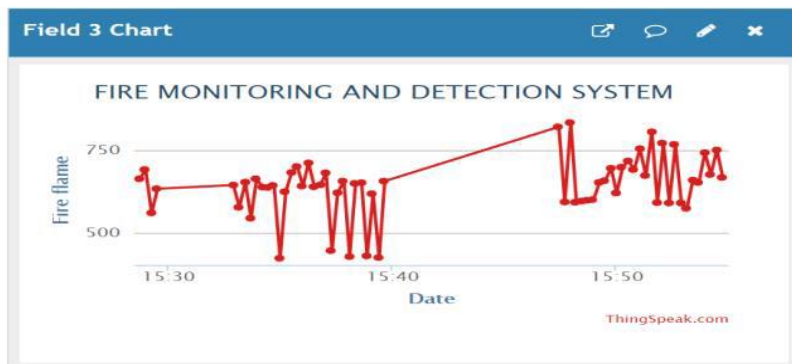
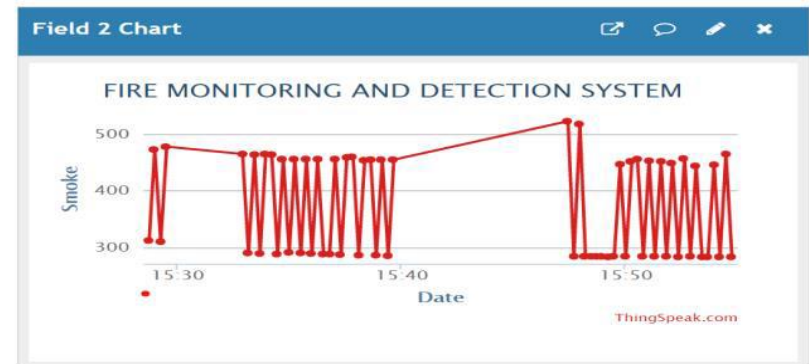
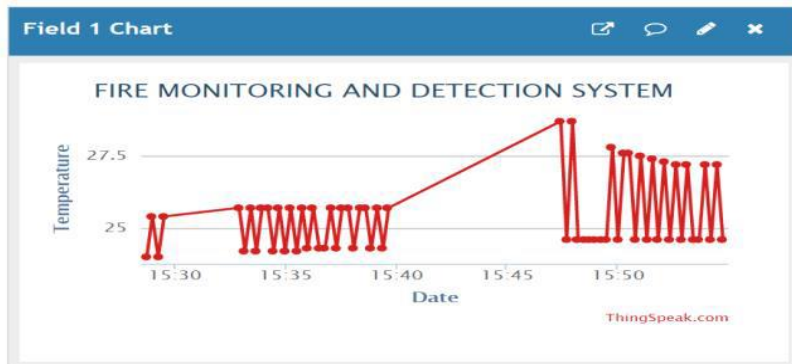

P.Rotich, H.Rambo, A.Geofrey and Dr. A.Sam, NM-AIST, Arusha, Tanzania

Data processing subsystem cont..

- The subsystem was able to receive data collected from the sensing subsystem in which the Raspberry Pi was the sink node. The received data were sent to the IoT cloud (Thing speak). The Thing speak is an Open source data platform and API for the IoT that enables us to collect, store, analyze, visualize, and act on data from sensors

Proceedings of the 7th International Electronic Conference on Sensors
Networks, 15 – 30 November, 2020, Sensors MDPI, Basel, Switzerland

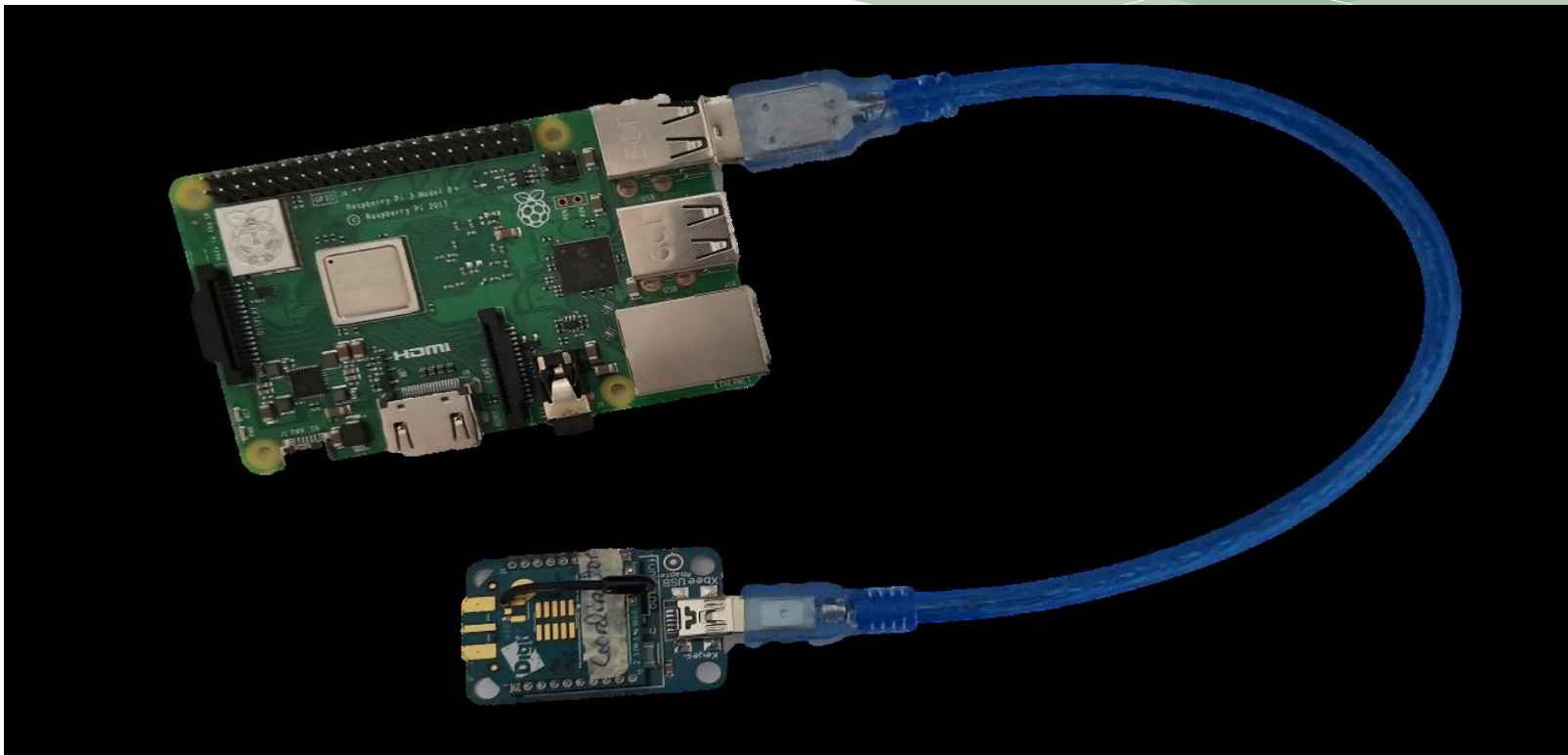

Raspberry Pi and ZigBee Coordinator

P.Rotich, H.Rambo, A.Geofrey and Dr. A.Sam, NM-AIST, Arusha, Tanzania

Proceedings of the 7th International Electronic Conference on Sensors Networks, 15 – 30 November, 2020, Sensors MDPI, Basel, Switzerland.

Mobile Application subsystem



➤ The mobile application is used for visualization of data from each shop in the market, in case of a fire outbreak at its initial stage the users receive the notification alarms.

P.Rotich, H.Rambo, A.Geofrey and Dr. A.Sam, NM-AIST, Arusha, Tanzania

Recommendation

- The demand of affordable early fire detection system is high; more systems are required even for the open market (many local markets) in Tanzania compared to closed market where the developed system is applicable. This system is limited by the coverage distance that is why it's applicable in the closed market; it does not go beyond 100 meters in line of sight. Thus we recommend for future development to increase the coverage distance between the transmitters and receivers where high power should be used.

References

1. E. K. Addai, "Trend of fire outbreaks in Ghana and ways to prevent these incidents," 2016. a.
2. Ash eri M. Mwidege; Herieth Rogath, "Socio-economic effects of market fires outbreaks: An evidence of Mbeya City, Tanzania," *International Journal of Research in Social Sciences*, 2014.
3. Barera Sarwar; Imran Sarwar Bajwa; Noreen Jamil; Shabana Ramzan; Nadeem Sarwar, "An Intelligent Fire Warning Application Using IoT and an Adaptive Neuro-Fuzzy Inference System," *Sensors*, 2019.
4. Majid Bahrepour; Nirvana Meratnia; Paul Havinga, "Automatic Fire Detection: A Survey from Wireless Sensor Network Perspective," *Pervasive System Group, Univeristy of Twente*, 2008
5. San-Miguel-Ayanz, J.; Ravail, N, "Active Fire Detection for Fire Emergency Management: Potential and Limitations for the Operational Use of Remote Sensing.," *Nat Hazards* 35, p. 361– 376, 2005.

References

6. Arrue B. C.; J. R. Matinez de Dios; A. Ollero, "An intelligent system for false alarm reduction in infrared forest-fire detection," *IEEE Intelligent Systems and their Applications*, vol. vol. 15, pp. 64-73, 2000.
7. A. M. & R. H. Mwidege, "Socio-economic effects of market fires outbreaks: An evidence of Mbeya City, Tanzania.," *International Journal of Research in Social Sciences*, pp. 4(3), 321, 2014.
8. Nnamdi Ilodiuba; Ugbebor John, "Classification of Causes and Strategies for Curbing Market Fire," *Archives of Current Research International*, pp. 1-13, 2017. a.
9. N. A rtim, "An introduction to fire detection, alarm, and automatic fire sprinklers," Northeast Document Conservation Center, 1999.
10. A. Ndibalema, " An Assessment of Fire Emergency Preparedness among Public Universities in Tanzania," *Doctoral dissertation, The Open University Of Tanzania*, 2015.

Proceedings of the 7th International Electronic Conference on Sensors Networks, 15 – 30 November, 2020, Sensors MDPI, Basel, Switzerland.



P.Rotich, H.Rambo, A.Geofrey and Dr. A.Sam, NM-AIST, Arusha, Tanzania