



Efficacy of FRP hooping in masonry domes

A simple numerical approach

IOCBD
2023

POLITECNICO
MILANO 1863

Alessandro Gandolfi^{1*}, Natalia Pingaro¹, Gabriele Milani¹

¹ Department of Architecture, Urban Planning and Construction Engineering, Politecnico di Milano, Italy

*correspondence: alessandro.gandolfi@polimi.it

MASONRY DOMES

STATEMENT OF THE ISSUE

- NOT ONLY NO-TENSION MATERIAL
- NO DOME = ARCH SIMPLIFICATIONS
- SIMPLE FRP BY FEM APPROACH

Clay Bricks: linear elastic
MORTAR JOINTS: nonlinear

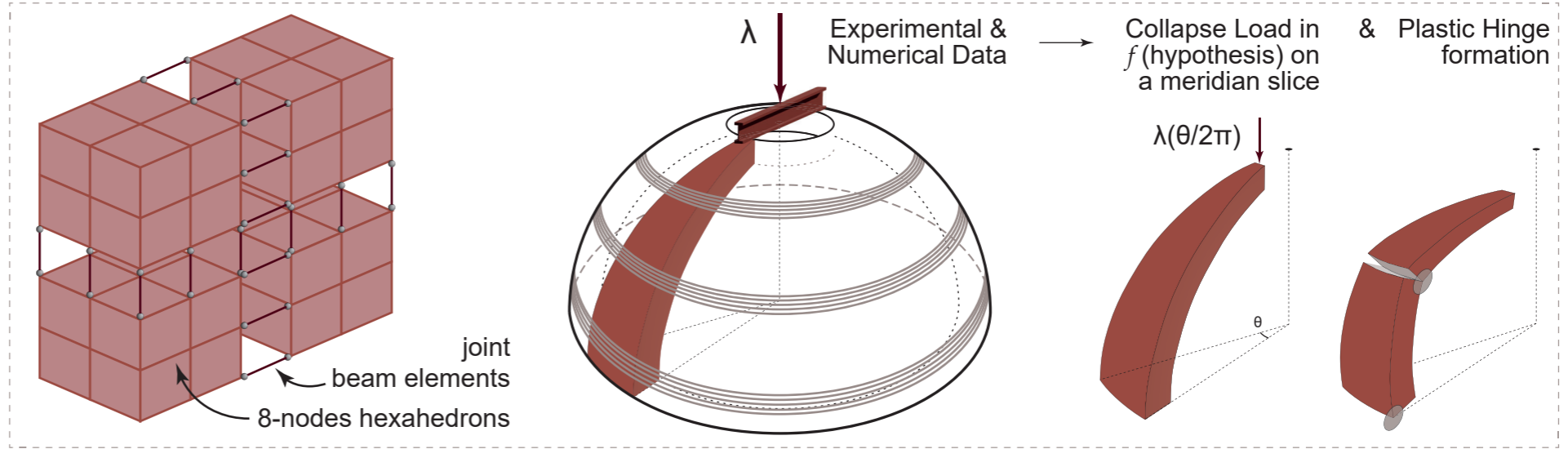

by Hypothesis:

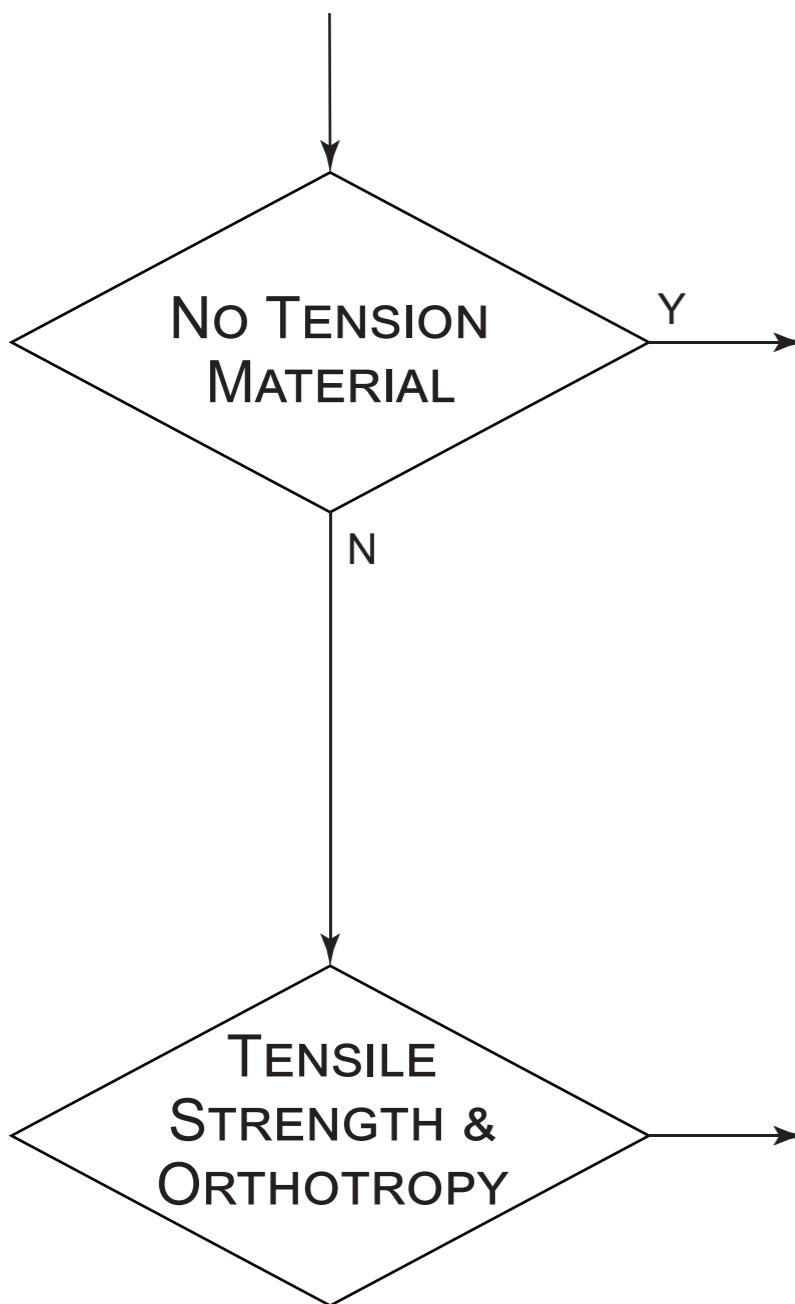

POINT CONTACTS

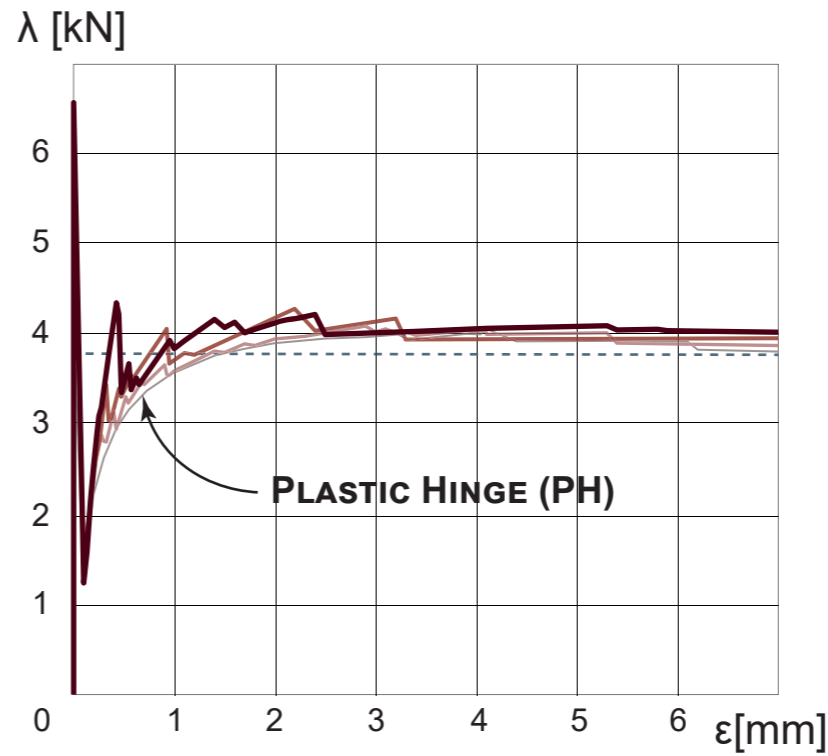
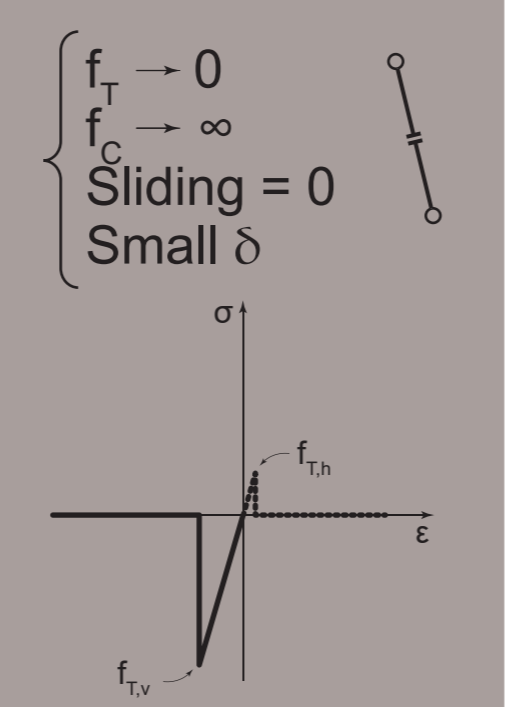

- LB Lim. Analysis [1]
- $f_{T,h} = 0.00$ MPa (NTM)
- $f_{T,h} = 0.05$ MPa
- $f_{T,h} = 0.07$ MPa
- $f_{T,h} = 0.10$ MPa

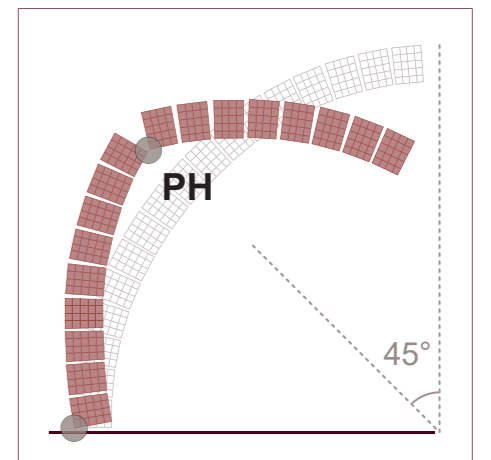

CUTOFF BARS

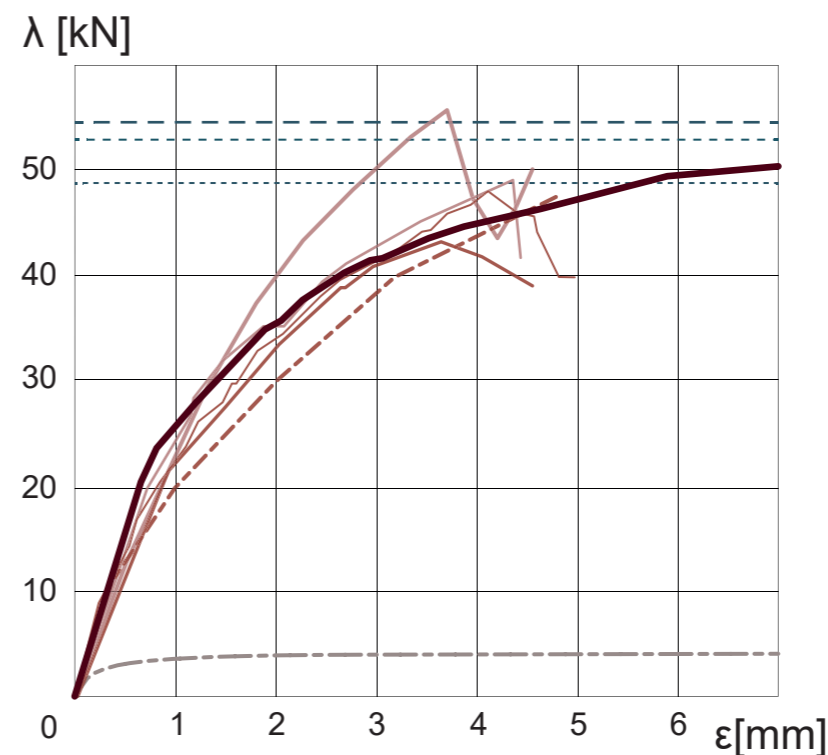
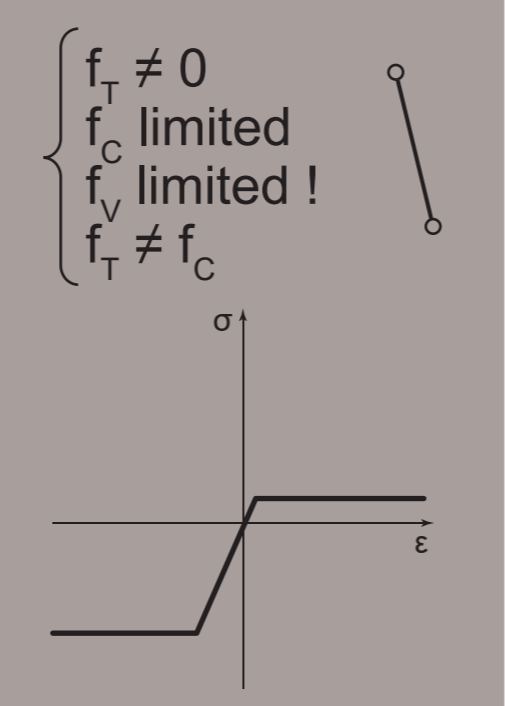

- UB Lim. Analysis [2]
- Nurbs UB LA [3]
- LB Lim. Analysis [4]
- DIANA FEM homogen. [2]
- DIANA FEM heterogen. [2]
- DSM model [5]
- QP model [5]
- Experimental Data [6,7]
- EPP CoB FEM
- NTM hypothesis

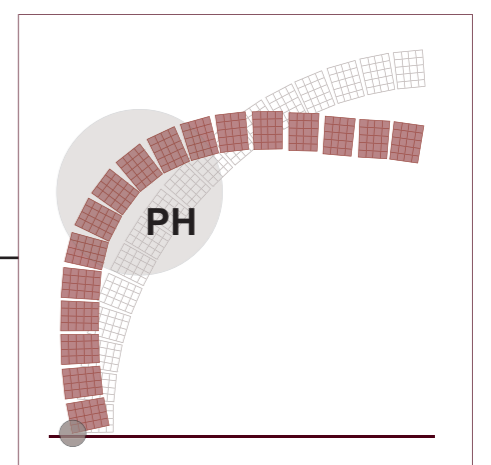

CUTOFF BARS

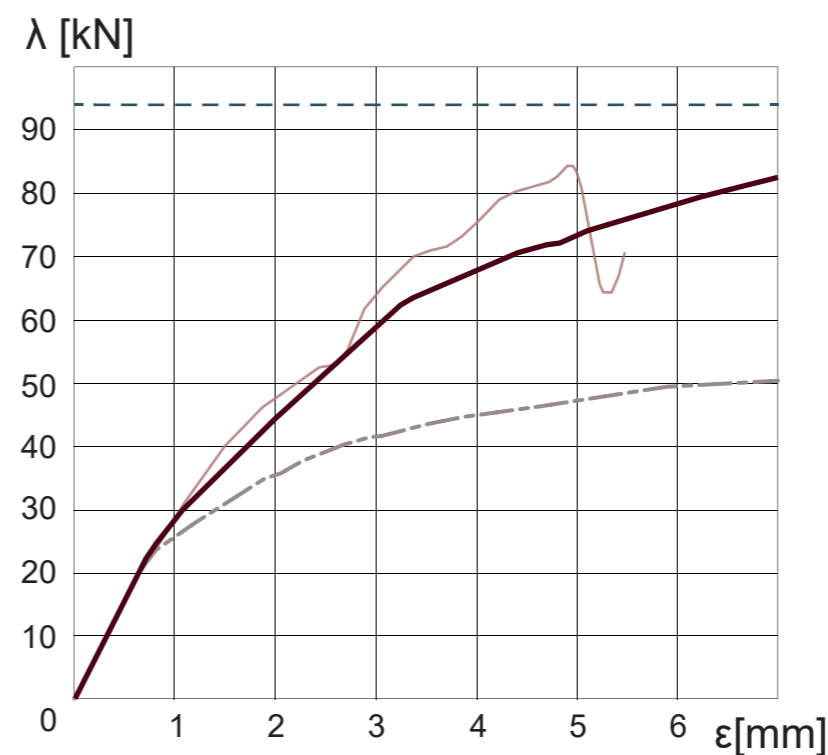
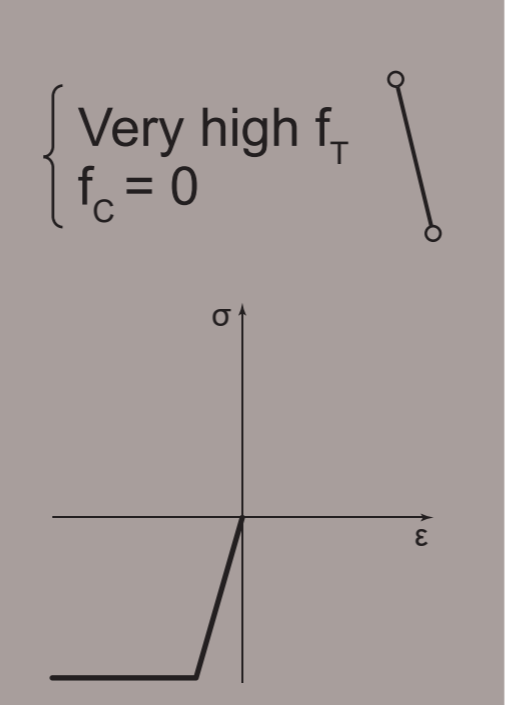

- UB Lim. Analysis FRP [2]
- DIANA FEM FRP [2]
- EPP CoB FEM
- EPP CoB FRP

CONCLUSIONS:

NTM MODEL → { 45° PH
CONSERV. λ

f_T + ORTHOTROPY → { SMEARED PH
ACCURATE λ

FRP MODEL BY CoB → 2λ INCREASE

REFERENCES:

1. D. Aita, G. Milani, and A. Taliervo, "Limit analysis of masonry double curvature structures: a comparison between different approaches," Mathematics and Mechanics of Solids. In Printing.
2. G. Milani, E. Milani, and A. Tralli, "Upper bound limit analysis model for FRP-reinforced masonry curved structures. Part II: Structural analyses," Comput Struct, vol. 87, no. 23–24, pp. 1534–1558, 2009.
3. A. Chiozzi, G. Milani, and A. Tralli, "A Genetic Algorithm NURBS-based new approach for fast kinematic limit analysis of masonry vaults," Comput Struct, vol. 182, pp. 187–204, 2017.
4. G. Milani, "Simple lower bound limit analysis model for masonry double curvature structures," Comput Struct, vol. 269, p. 106831, 2022.
5. Milani, G., & Tralli, A. (2012). A simple meso-macro model based on SQP for the non-linear analysis of masonry double curvature structures. IJSS, 49(5), 808–834.
6. P. Foraboschi, "Strengthening of Masonry Arches with Fiber-Reinforced Polymer Strips," Journal of Composites for Construction, vol. 8, no. 3, pp. 191–202, 2004.
7. G. Creazza, A. V. Saetta, R. Matteazzi, and R. V. Vitaliani, "Analyses of masonry vaulted structures by using 3-D damage model," ECCOMAS 2000, no. September, pp. 11–14, 2000.