

Proceeding Paper

Ultrasonic Oscillating Temperature Sensor for Operation in Air [†]

Ali Elyounsi and Alexander N. Kalashnikov ^{*}

Department of Engineering and Mathematics, Sheffield Hallam University; a.kalashnikov@shu.ac.uk

^{*} Correspondence: a.kalashnikov@shu.ac.uk

[†] Presented at 8th International Electronic Conference on Sensors and Applications, 1–15 November 2021;

Available online: <https://ecsa-8.sciforum.net>.

Abstract: Ultrasonic oscillating temperature sensors (UOTSs) were shown to respond to temperature changes in aqueous solutions faster than conventional temperatures sensors [1]. This study describes a recently developed air UOTS and presents experimental results on its response to air temperature step changes recorded simultaneously using AHT20 and BMP280 air temperature sensors. These results demonstrate a remarkably fast UOTS response time.

Keywords: oscillating temperature sensor; UOTS; thermal step change; thermal response time; AHT20; BMP280

1. Introduction

Keeping the room temperature comfortable for the inhabitants of modern buildings comes at a substantial cost that includes greenhouse gas emissions. For example, ‘In the US, 38% of greenhouse gas emissions from residential housing are produced from heating and cooling rooms... It is estimated that 19% of the UK’s greenhouse gas emissions come from warming up the places we live and work ...’ [2]. Reducing these figures is possible via superior indoor temperature regulation, which requires sensing temperature via a temperature sensor(s). Although the global market size for temperature sensors was estimated at 6.3 billion USD in 2020, with a projected annual growth of 4.8% through 2027 [3], not all of these sensors are suitable for air temperature measurement (e.g., infrared sensors). Additionally, air temperature can be notably uneven across a room. Thus, several conventional temperature sensors might be required for energy-efficient temperature control geared towards environmental comfort. Ultrasonic oscillating temperature sensors (UOTSs) can measure temperature across the entire ultrasonic pathways almost instantly almost instantly [1], which makes them a serious contender as an alternative to conventional air temperature sensors for indoor climate control applications.

In this study, we describe a recently developed air UOTS and present experimental results on its responses to air temperature step changes recorded simultaneously along with the responses of AHT20 and BMP280 air temperature sensors.

2. Experimental Equipment, Setup, and Procedure

A UOTS consists of a pair of ultrasonic transducers and an electronic driver, which form a closed signal loop [4]. The driver can consist of an amplifier—and may additionally include a phase shifter and/or a band-pass filter—and can be realised using various electronic components [5,6]. We used an amplifier assembled using a dual operational amplifier (opamp) (Figure 1), with U1 buffering the output signal of the UOTS before it reached the standalone eight-digit frequency counter, PLJ-8LED-C [7], and U2 compensating for acoustical and electrical losses in the signal loop. Using Munsen rings, 40 kHz air ultrasound transducers were attached to a standard 20 × 20 aluminium profile at a distance of

Citation: Elyounsi, A.; Kalashnikov, A.N. Ultrasonic Oscillating Temperature Sensor for Operation in Air. *2021*, *3*, x. <https://doi.org/10.3390/xxxxx>

Academic Editor(s):

Published: date

Publisher’s Note: MDPI stays neutral with regard to jurisdictional claims in published maps and institutional affiliations.



Copyright: © 2021 by the authors. Submitted for possible open access publication under the terms and conditions of the Creative Commons Attribution (CC BY) license (<https://creativecommons.org/licenses/by/4.0/>).

125 mm apart (Figure 2). The connected components of the UOTS are illustrated in Figure 3.

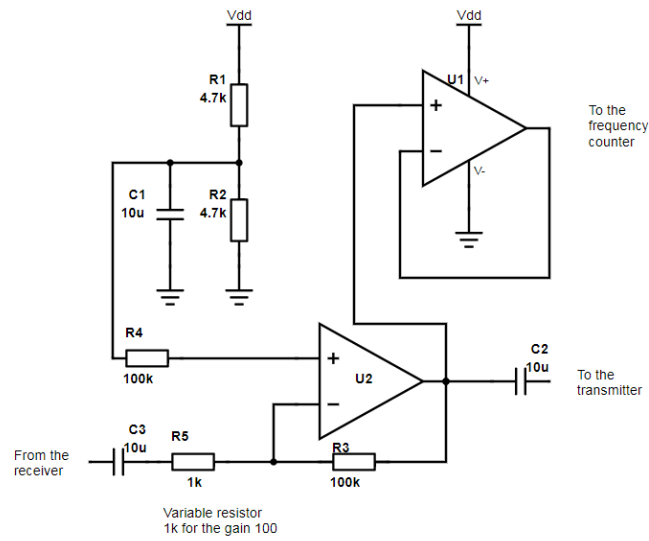

Figure 1. Schematic diagram of the electronic driver.

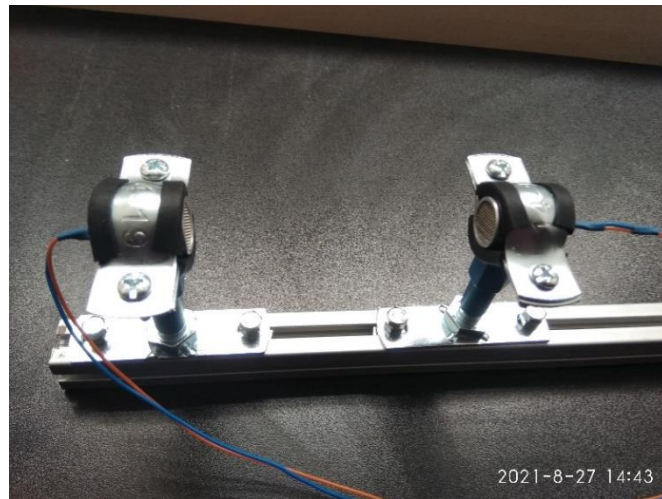

Figure 2. Fixture for ultrasonic transducers.

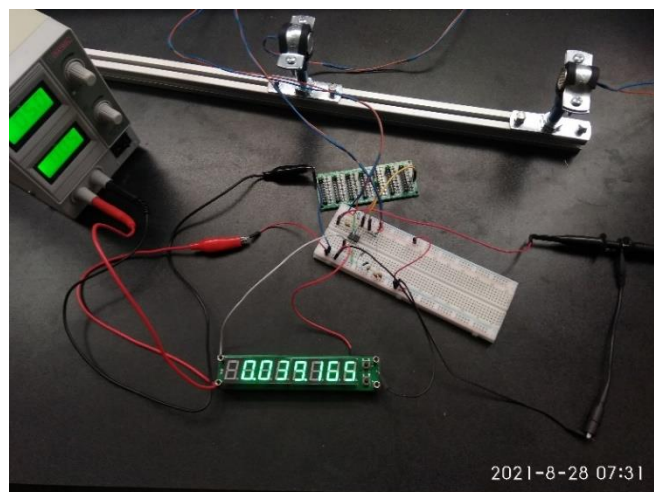

Figure 3. Connected components of the UOTS in operation.

The air temperature was measured using conventional temperature sensors AHT20 and BMP280, which came mounted on the same circuit board. The board was connected via an I2C interface to a Seeeduino Xiao [8] with an expansion board and a USB power bank, as illustrated in Figure 4.

The experimental setup also included a domestic hair dryer rated at 2 kW, which provided step changes in temperature, and a cardboard enclosure to house the temperature sensors in a confined space (Figures 5 and 6).

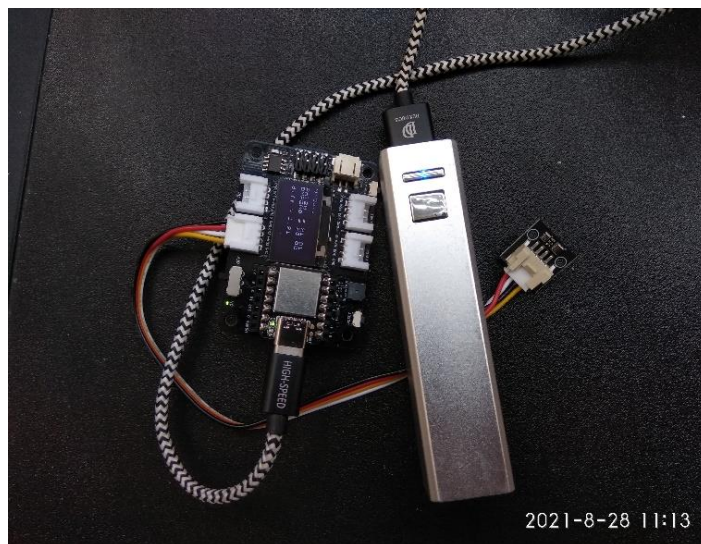

Figure 4. Temperature measurement setup with conventional air temperature sensors AHT20 and BMP280 on the same board.



Figure 5. Complete experimental setup in operation.



Figure 6. Sensors and hairdryer inside a cardboard enclosure outside of a cardboard enclosure.

The experimental procedure was as follows:

- First, the power bank was switched on, and the readings of both the conventional temperature sensors were recorded to a secure digital (SD) card every second.
- A video recording, made using a mobile phone that faced the frequency counter displaying the UOTS frequency every 1 s, was initiated.
- The hairdryer was switched on remotely for a few seconds. Because the hairdryer was not attached to the aluminium profile, it moved slightly every time it was switched on.
- After some time, the video recording was stopped.
- The hairdryer was switched on four times, twice after the air in the enclosure had cooled down to approximately the temperature of the room, and twice in a quick succession.
- The recorded temperatures were transferred from the SD card to a personal computer.
- The recorded videos were transferred to a personal computer and played with frequent pauses to record the changing readings on the frequency counter. Because it was very difficult if they were the same, the number of recorded points was about 5% less than the duration of the video in seconds.
- All the data was imported into a spreadsheet, and relevant graphs were plotted. The regions in the graphs with sharp peaks in the readings of the UOTS and the conventional air temperature sensors were identified. The data recorded via the BMP280 sensor was processed to remove a 1.25 °C bias that was observed both in our data and in the literature [9,10].

3. Experimental Results

The experimental results, which were collected and processed according to the procedures described in the preceding section, are presented in Figures 7–11. Figure 7 presents temperature readings reported by the conventional temperature sensors throughout the experiment (minus the 1.25 °C bias for the BMP280). The graphs show that even 10 min after the last step change, the readings did not return to the levels observed before the step change. The readings of the different sensors are in good agreement, except for the instances of step temperature changes (Figure 8). We attribute these disparities to differences in the response times of the sensors.

Figures 9–11 present changes in the readings of both the conventional air temperature sensors and the UOTS (less 38 kHz) for three distinct temperature step change regions. On all occasions, the readings rose speedily until the hairdryer was switched off,

and then returned to the pre-step levels—quickly on the UOTS, but rather slowly on the conventional air sensors. On one occasion, the output frequency of the UOTS included a clear single point outlier (Figure 11, right). We checked this point several times and are confident that the value shown on the graph was displayed by the frequency counter. It could be merely an error (the only error of the frequency counter) or a rollover of the output frequency of the UOTS as the would-be oscillation frequency crossed over the passband of the closed signal loop.

The experimental results show that even properly thermally coupled conventional air temperature sensors placed on the same circuit board can record values that differ within a range of $-0.55\text{ }^{\circ}\text{C}$ to $+0.85\text{ }^{\circ}\text{C}$ if the air temperature changes rapidly. When the cause of the temperature step change was removed, it took considerable time for the readings to return to their pre-step levels. In contrast, the readings on the UOTS rose quickly on a step change and fell sharply when the step change ended.

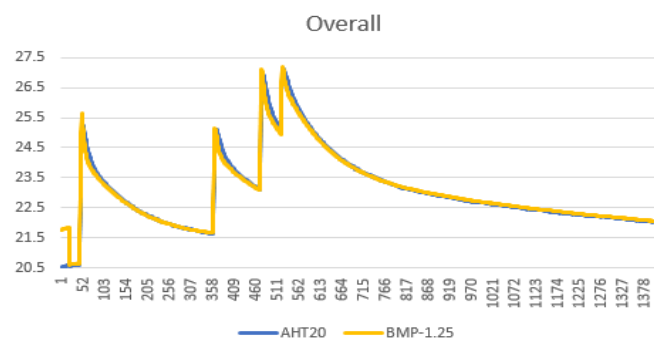

Figure 7. Four temperature step changes recorded via the conventional air temperature sensors.

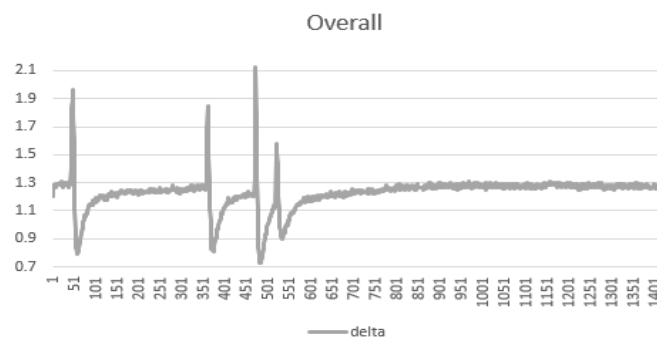

Figure 8. Difference between readings of the conventional air temperature sensors.

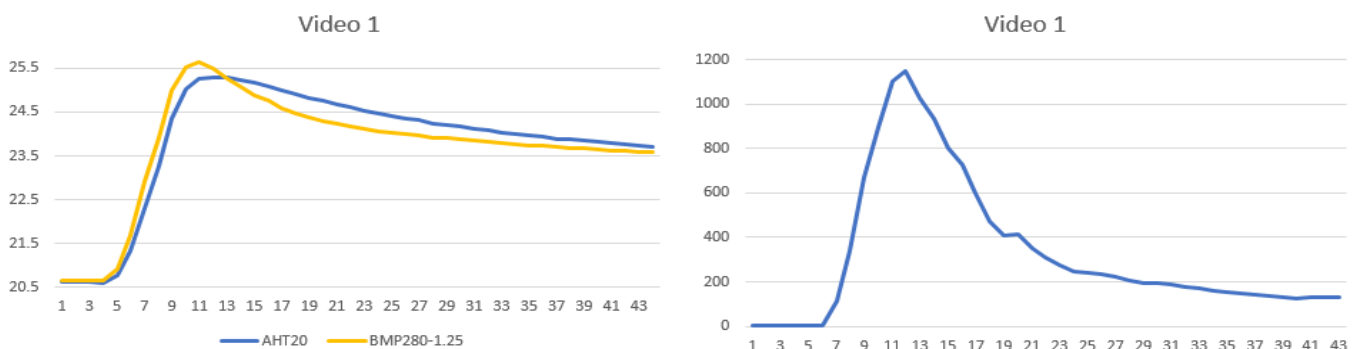

Figure 9. Sensor readings for each second of the first step change (left: AHT20 and BMP280, in centigrade; right: the UOTS, in Hz).

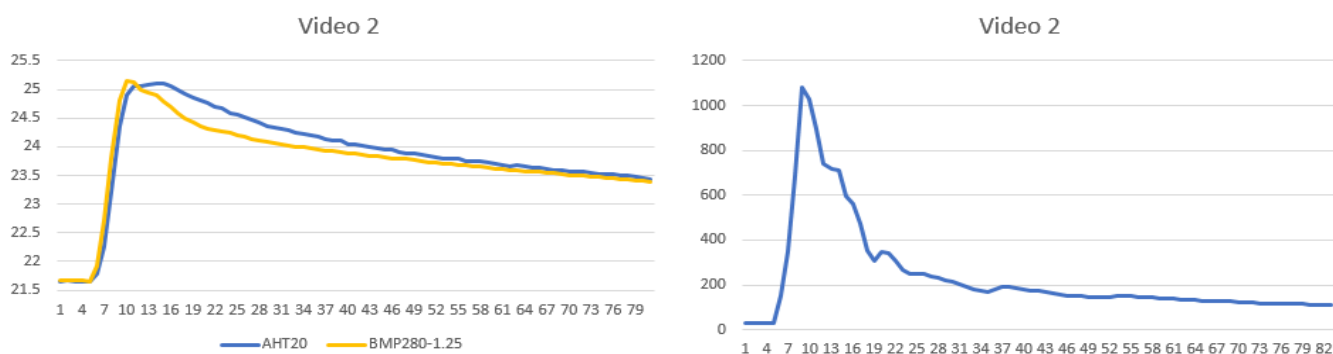

Figure 10. Sensor readings for each second of the second step change (**left:** AHT20 and BMP280, in centigrade; **right:** the UOTS, in Hz).

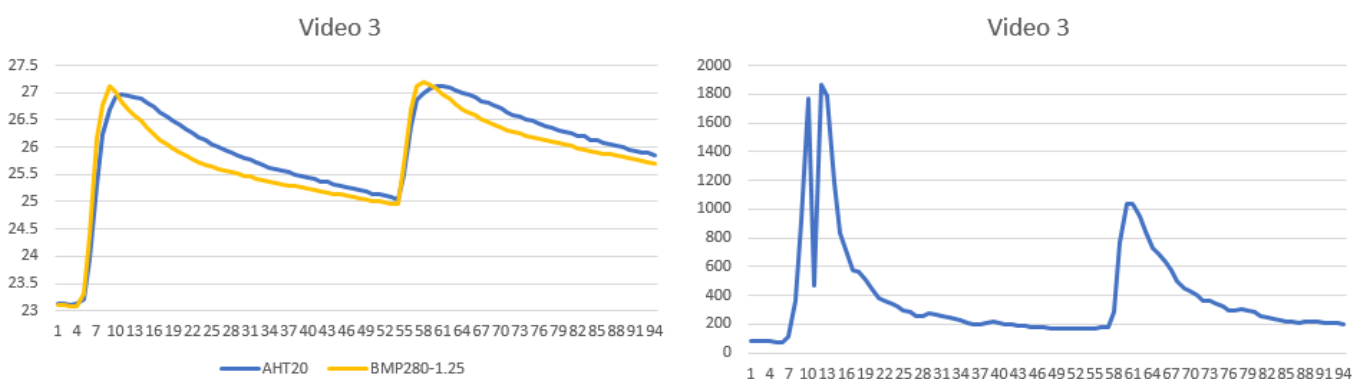

Figure 11. Sensor readings for each second of the third and fourth step changes (**left:** AHT20 and BMP280, in centigrade; **right:** the UOTS, in Hz).

4. Summary, Conclusions, and Future Research

We present a recently developed air UOTS, along with detailed equipment and experimental procedures for comparing its response time with the response time of two conventional air temperature sensors, AHT20 and BMP280. The experimental results qualitatively verify the much faster response time of the UOTS. However, this outcome could not be quantified at this stage.

It is important to note that a UOTS registers changes in the ultrasound velocity across the air pathway, which depend not only on the temperature but also on humidity. However, the experimental data shows that the influence of humidity under tolerable room conditions is one order of magnitude lower than that of temperature [11].

Although the output frequency measurement procedure for the UOTS facilitated the obtaining of reliable results, its granularity of 1 s is insufficient for full characterisation of the properties of the UOTS. There is a need to develop a frequency metre that can measure the input frequency of the UOTS with high accuracy and at high resolution while recording the values multiple times per second. This can be implemented using a temperature-controlled crystal oscillator to provide the reference frequency and a microcontroller with a capture timer(s).

To calibrate the developed UOTS, it is necessary to develop a measurement network that records the temperatures across the complete ultrasonic pathway. If the temperatures along the pathway are altered in a controlled quasi-static manner, it becomes possible to associate the output frequencies of the UOTS with the aggregate air temperatures between the transducers, as required for domestic use.

A significantly large gain of 100 was required to operate the UOTS at a 125 mm distance between the transducers. Because ultrasound energy spreads over a spherical surface in the far field, achieving the intended operating distance between the transducers of several metres may require a gain so large that it renders the UOTS unstable.

Institutional Review Board Statement:

Informed Consent Statement:

Data Availability Statement:

References

1. Hashmi, A.; Kalashnikov, A.N. Sensor data fusion for responsive high resolution ultrasonic temperature measurement using piezoelectric transducers. *Ultrasonics* 2019, 99, 105969, ISSN 0041-624X, <https://doi.org/10.1016/j.ultras.2019.105969>.
2. Cole, L. How to Cut Carbon out of Your Heating, BBC Future, 17 Nov 2020. Available online: <https://www.bbc.com/future/article/20201116-climate-change-how-to-cut-the-carbon-emissions-from-heating> (accessed on September 2021).
3. Temperature Sensor Market by Product Type (Thermocouples, RTDs, Thermistors, Temperature Sensor ICs, Bimetallic, Infrared, and Fiber Optic Temperature Sensors), Output, End-user Industry, and Region—Global Forecast to 2027, MarketsandMarkets, March 2020, online summary. Available online: <https://www.marketsandmarkets.com/Market-Reports/temperature-sensor-market-522.html> (accessed on September 2021).
4. Alzebda, S.; Kalashnikov, A.N. Ultrasonic sensing of temperature of liquids using inexpensive narrowband piezoelectric transducers. *IEEE Trans. Ultrason. Ferroelectr. Freq. Control.* 2010, 57, 2704–2711, doi: 10.1109/TUFFC.2010.1744.
5. Popejoy, P.; Alzebda, S.; Hashmi, A.; Harriott, M.; Sonbul, O.; Kalashnikov, A.; Hayes-Gill, B. Comparison of implementations of driving electronics for ultrasonic oscillating sensors. In Proceedings of the 2012 IEEE International Ultrasonics Symposium, Dresden, Germany, 7–10 October 2012; pp. 2427–2430, doi: 10.1109/ULTSYM.2012.0607.
6. Hashmi, A.; Malakoutikhah, M.; Light, R.A.; Kalashnikov, A.N. Embedded supervisory control and output reporting for the oscillating ultrasonic temperature sensors. In: Silhavy, R.; Senkerik, R., Kominkova, Z., Oplatkova, Prokopova, Z., Silhavy, P., Eds.; *Intelligent Systems in Cybernetics and Automation Theory*; Springer: 2015; pp. 139–150.
7. 8-digit LED Frequency Counter Module. Model PLJ-8LED-C. User Manual. Available online: <https://www.manualslib.com/manual/1522425/Sanjian-Studio-Plj-8led-C.html> (accessed on September 2021).
8. Seeeduino Xiao, Product Support Page. Available online: <https://wiki.seeedstudio.com/Seeeduino-XIAO/> (accessed on September 2021).
9. Liutyi, O. Test i2c Humidity Sensors. available online: v5 sensors board <https://wiki.liutyi.info/display/ARDUINO/v5+Sensors+Board+project>; test from room to freezer <https://wiki.liutyi.info/display/ARDUINO/Test+10+v5+board+in+Freezer>, (accessed on September 2021).
10. BME 280 Temp Offset/Self Heating, Adafruit’s Forum Discussion, Started Nov 2019. Available online: <https://forums.adafruit.com/viewtopic.php?f=19&p=534525> (accessed on September 2021).
11. Speed of Sound in Air, Section 2.4.1 “The Speed and Attenuation of Sound”, Kaye & Laby online. Available online: https://web.archive.org/web/20190508003406/http://www.kayelaby.npl.co.uk/general_physics/2_4/2_4_1.html#speed_of_sound_in_air (accessed on September 2021).