

Coal fly ash zeolites – from synthesis to application in acetone optical detection

K. Lazarova¹, S. Boycheva², M. Vasileva¹, D. Zgureva-Filipova³ and T. Babeva¹

¹Institute of Optical Materials and Technologies “Acad. J. Malinowski”, Bulgarian Academy of Sciences, Acad. G. Bonchev str., bl. 109, 1113 Sofia, Bulgaria.

²Technical University of Sofia, Department of Thermal and Nuclear Power Engineering, 8 Kl. Ohridsky Blvd., 1000 Sofia, Bulgaria.

³Technical University of Sofia, College of Energy and Electronics, 8 Kl. Ohridsky Blvd., 1000 Sofia, Bulgaria.



Technical University of Sofia
We succeed!



Table of content

1. Coal ash - pollutants and possibilities for their utilization
2. Na-X (Faujasite/FAU) zeolites
3. Thin films from Nb_2O_5 doped with milled zeolites
4. Characterization of thin composite films - optical and sensing properties
5. Summary

Coal ash - pollutants and possibilities for their utilization

Coal is the largest source of energy from fossil fuels used for generating electricity in the world



releases of gaseous emissions - sulfur, nitrogen and carbon oxides

generation of solid waste - ash

- Its macro-component composition is considered as an alumosilicate material.
- Different opportunities for utilization have been explored, including for the synthesis of zeolites.

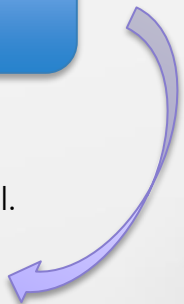

The electricity produced in Bulgaria in 2017, allocated according to the primary energy resource and the used production technology.

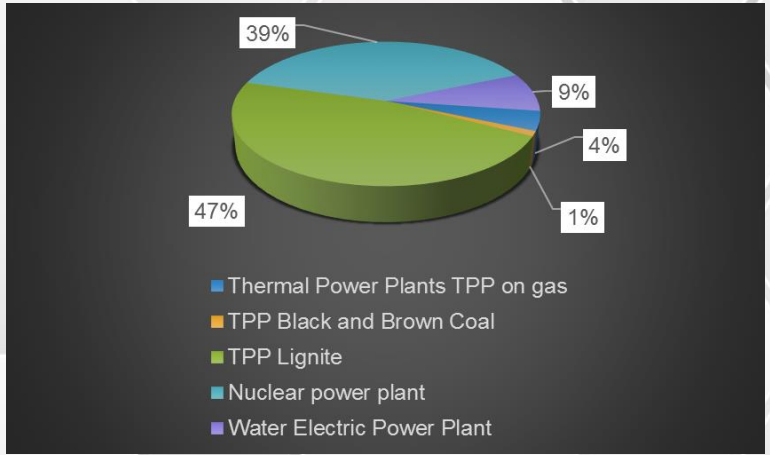

Coal ash - pollutants and possibilities for their utilization

Carbon dioxide CO₂

Volatile Organic Compounds (VOCs)



For the purposes of developing CO₂ capture technologies in the search for new solid phase sorbents, **zeolites** have also been studied.



They have valuable features such as :

adsorbents

catalysts

ion exchangers

separators

Zeolites are materials with a unique porous structure with active centers and mobile cations of alkaline and alkaline-earth metals.

Faujasite (FAU)

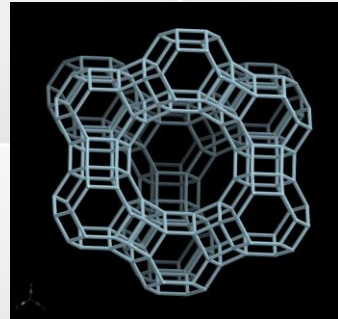

FAU

Linde Type A Zeolite (LTA)

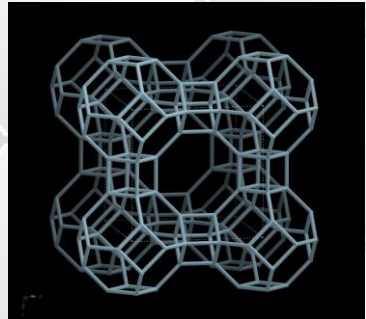

LTA

Na-X(FAU) zeolites

HIGH SILICA ZEOLITE

Faujasite (FAU) is a rare natural zeolite which has a synthetic counterpart, zeolite X. The sodium form of the synthetic zeolite X – Na-X is widely used because of its structural supercage, with a large pore size and high specific surface area.

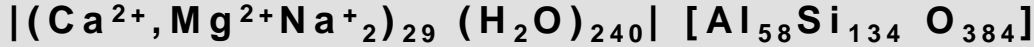
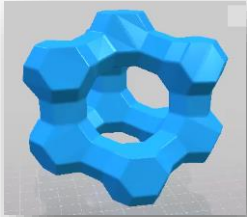

Maximal diameter of sphere:

- ✓ To be included in the structure - 11.24 Å
- ✓ To diffuse around the structure - 7.35 Å

Free volume: 27 %

FAU

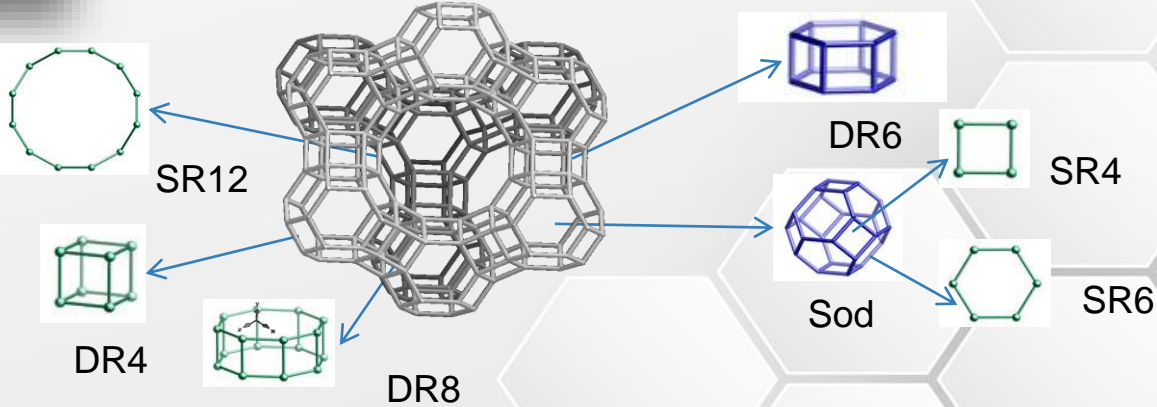

Na-X(FAU) zeolites

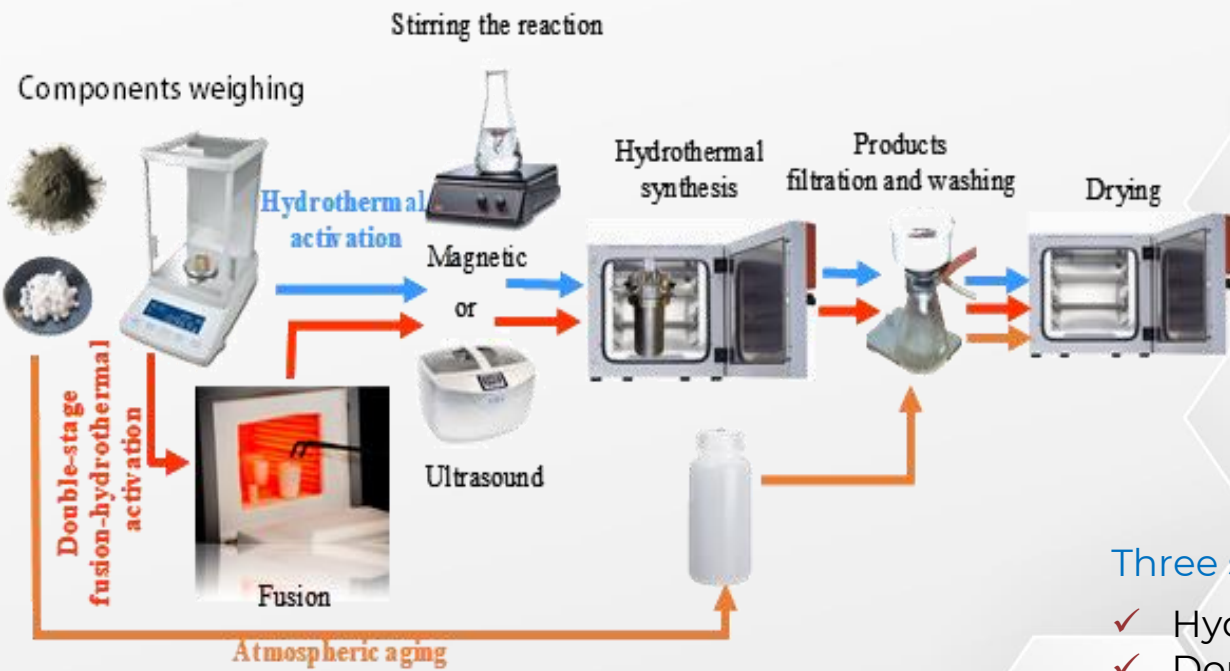

Integrated scheme of the synthesis approaches

Coal ash alkaline conversion to zeolites

- Three synthesis approaches:
- ✓ Hydrothermal activation
 - ✓ Double stage fusion-hydrothermal activation
 - ✓ Atmospheric crystallization – Quasi-natural crystallization process

Na-X(FAU) zeolites

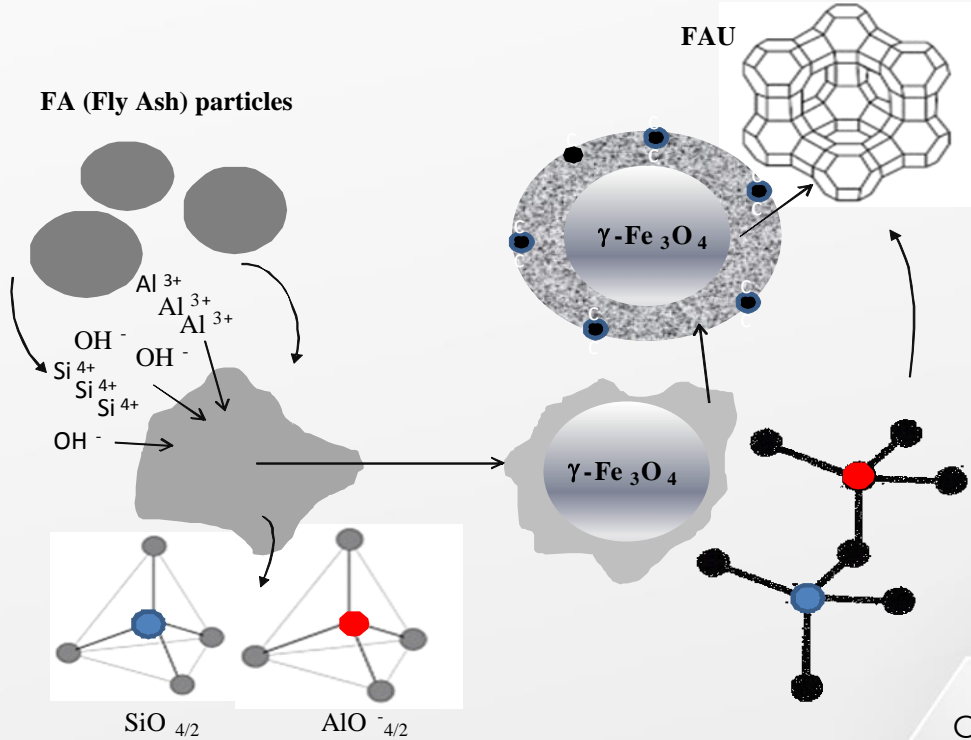

Coal ash alkaline conversion to FAU zeolites

Coal fly ash zeolites of the FAU type are easily synthesized by the alkaline conversion of coal fly ash, saving raw materials by utilizing solid waste.

Na-X(FAU) zeolites

LTA and FAU zeolites have the highest carbon capture potential



highly developed specific surface

FAU	LTA
Pore size 7.35Å	Pore size 4.21Å
Free volume 27.42 %	Free volume 21.43 %



Allowing the physical adsorption of molecules of CO₂ from size 3.2 Å

Zeolite from coal ash



They are distinguished from zeolites synthesized from pure starting materials



High content of iron oxides (γ -Fe₂O₃, α -Fe₂O₃, γ -Fe₃O₄)



In combination with microcomponents such as Cu, Co, Mn, V, W

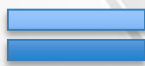

Determine their good catalytic activity

Na-X(FAU) zeolites

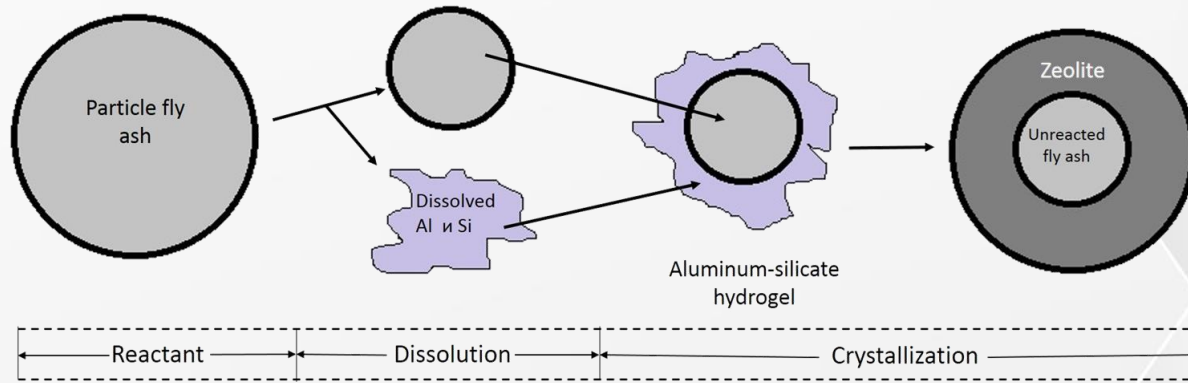

The process is carried out in three stages:

- 1) Dissolving aluminosilicates of the ash in the alkaline solution;
- 2) Precipitation of an aluminosilicate hydrogel;
- 3) Crystallization of zeolite from the aluminosilicate gel on germinator.

Na-X(FAU) zeolites

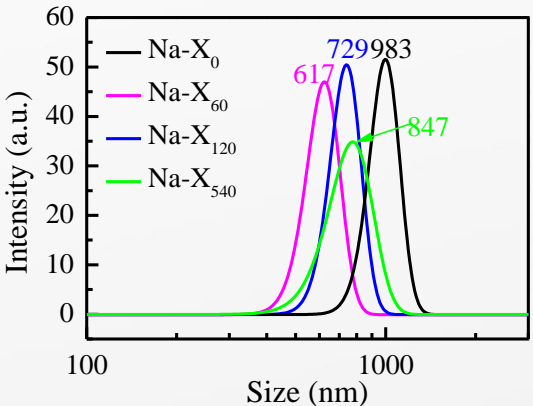

DLS curves for colloidal aqueous solutions of initial Na-X₀ zeolites and zeolites after milling for 60, 120, and 540 s.

Na-X type zeolites obtained



Zeolites are subjected to subsequent wet milling in a ball mill to reduce their size to sub-micron values.

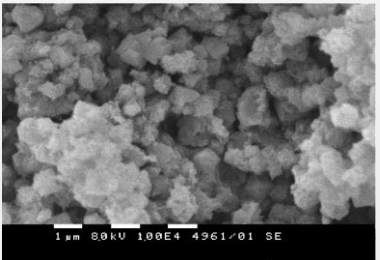

Not milled zeolites Na-X

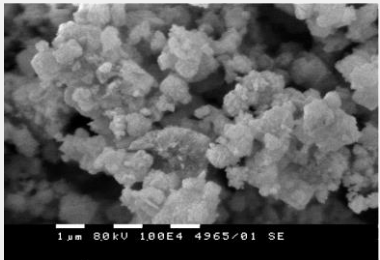

Milled 60 seconds

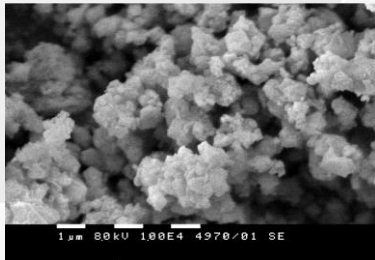

Milled 120 seconds

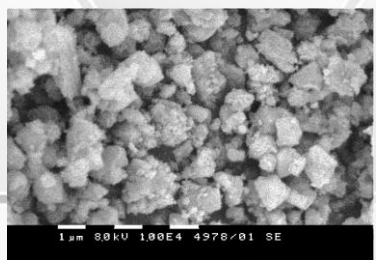

Milled 540 seconds

Na-X(FAU) zeolites

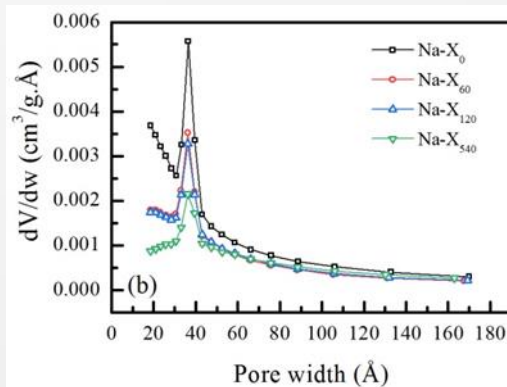
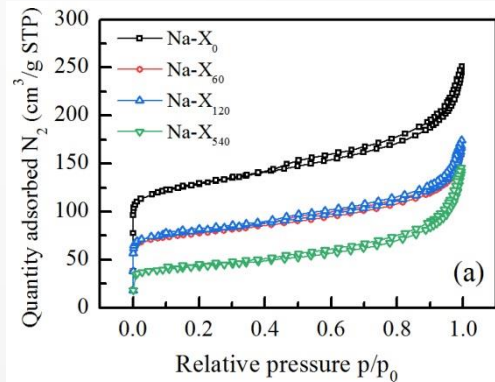

Experimental N_2 adsorption/desorption isotherms (a) and BJH plot of pore size distribution (b) of parent Na-X zeolites and zeolites after milling for 60, 120, and 540 s.

- ✓ Non-milled Na-X zeolite possesses the highest free volume indicated by an intensive peak at a pore width range of 35–45 Å, and a trend of increasing the pore volume in the direction of the micropore sizes.
- ✓ The main part of the free volume at all samples is provided by pores with a width of 38 Å, as the BJH plots of Na-X₆₀ and Na-X₁₂₀ almost overlap but the intensity of the peaks determining the pore volume is reduced as compared with Na-X₀.
- ✓ The sample Na-X₅₄₀ possesses drastically reduced free pore volume, which shows that the excessively prolonged milling time leads to destruction of the zeolite framework.

Thin films from Nb₂O₅ doped with milled zeolites

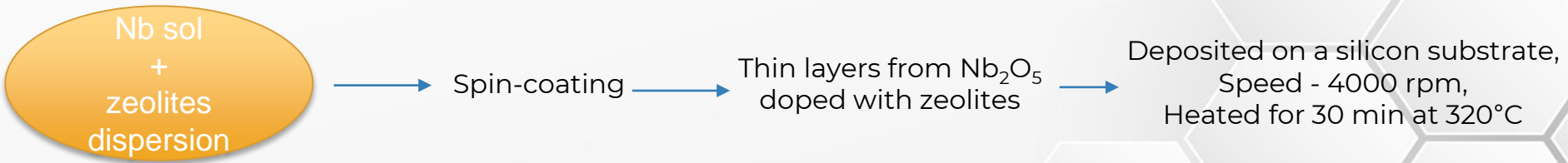

Nb₂O₅ composite thin films with two different levels of doping with Na-X zeolites were deposited on silicon substrates - 1% and 5%

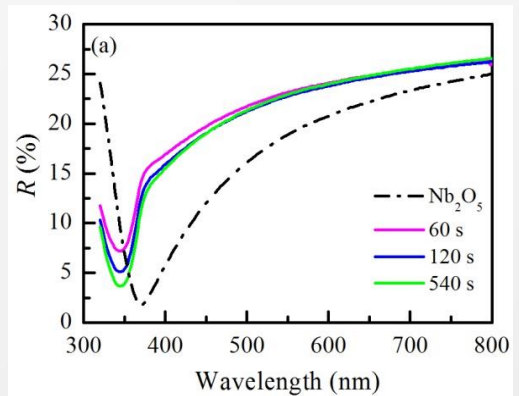

n, k и d - calculated by nonlinear algorithm for minimizing the difference between measured and calculated values of the reflectance R

Reflectance spectra of thin Nb₂O₅ film and composite films of Nb₂O₅ doped with 5% Na-X zeolites milled for 60 s, 120 s, and 540 s.

Characterization of thin composite films - optical and sensing properties

Sample/ Variable	Pure Nb ₂ O ₅	Na-X (1%)/Nb ₂ O ₅			Na-X (5%)/Nb ₂ O ₅		
		60 s	120 s	540 s	60 s	120 s	540 s
n *	2.06	2.00	1.93	1.98	1.73	1.83	1.87
k *	0.017	0.018	0.018	0.018	0.017	0.017	0.017
d (nm)	37	33	34	34	39	37	36
S_q (nm)	4.5 ± 1.2	5 ± 0.3	5.8 ± 1.4	4.3 ± 1	8 ± 2.4	6.2 ± 1.4	6.6 ± 0.9
Δn	-	0.42 × 10 ⁻²	1.08 × 10 ⁻²	<1 × 10 ⁻³	1.16 × 10 ⁻²	4.44 × 10 ⁻²	1 × 10 ⁻³

* Values of n and k are taken at a wavelength of 600 nm.

Refractive index n, extinction coefficient k, thickness d, surface rms roughness S_q, and refractive index change Δn upon exposure to acetone vapors of thin films from pure Nb₂O₅ and Nb₂O₅ doped with Na-X zeolites wet milled for 60, 120, and 540 s. [1]

- ✓ Refractive index of composite films is lower as compared with the oxide matrix. The reduction in the refractive index depends on the concentration of zeolites and is stronger for highly doped samples.
- ✓ For the composite with 5% Na-X zeolites, the refractive index increases with the duration of milling, while a minimum is observed for the 1% doped composite when Na-X zeolites milled for 120 s are used as dopants.
- ✓ The milling duration does not influence the film roughness.

Characterization of thin composite films - optical and sensing properties

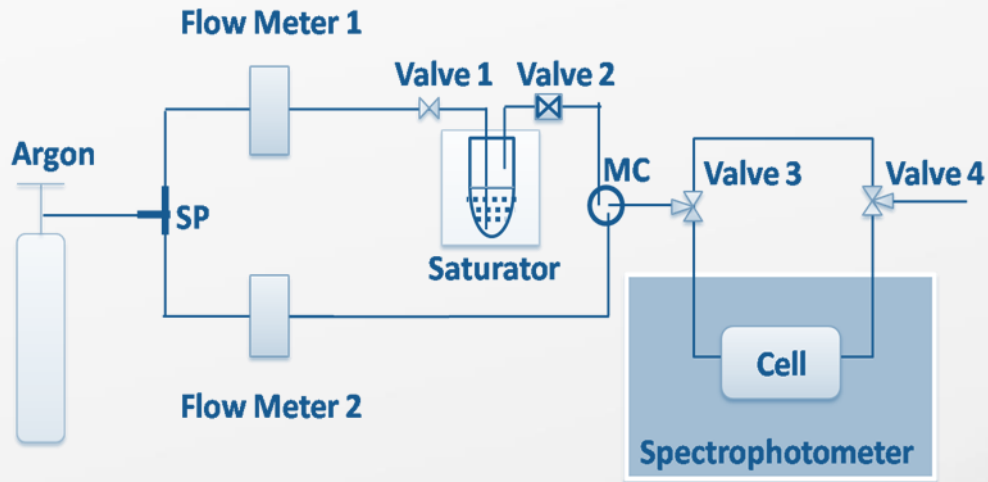

Schematic process of testing the sensing properties of the films toward acetone or ethanol vapors.

Changes in reflectance induced as a result of exposure to acetone and ethanol vapors:

$$\Delta R_{\max} = |R_{\text{ac/et}} - R_{\text{argon}}|$$

Characterization of thin composite films - optical and sensing properties

Acetone

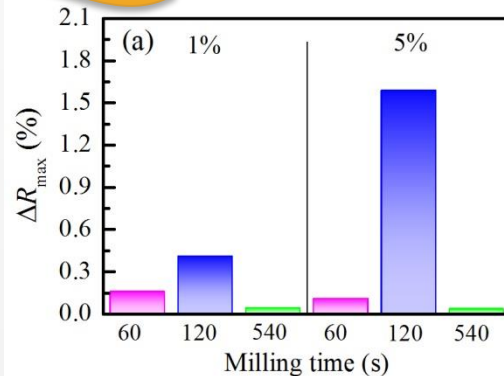

Ethanol

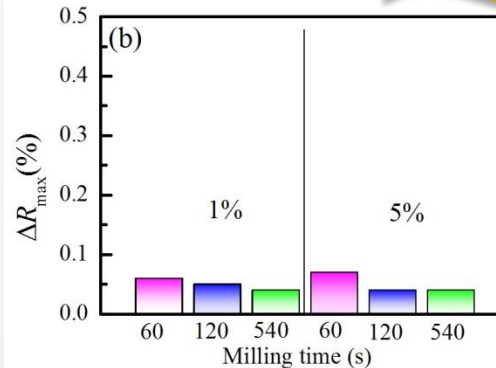

This result clearly indicates the selectivity of $\text{Nb}_2\text{O}_5/\text{Na-X}$ composite thin films toward acetone.

- ✓ For acetone vapors, the same dependence of the reflectance change ΔR_{\max} on the milling time is clearly observed for both zeolite concentrations.
- ✓ The greatest change is obtained for films doped with zeolites milled for 120 s, and the smallest for 540 s.
- ✓ Significant decrease in films response to ethanol vapors as compared to acetone.
- ✓ The maximum value for ΔR_{\max} achieved is 0.07 % (more than 20 times smaller as compared to the response towards acetone vapors). [1]

Summary

1. Zeolite Na-X synthesized by ultrasonic-assisted double stage fusion-hydrothermal alkaline conversion of coal fly ash are successfully incorporated in Nb_2O_5 thin matrix and the composite films thus obtained are applied as sensitive elements for optical sensing of vapors.
2. Increasing the concentration of zeolites leads to a decrease in the refractive index. The reduction is stronger for highly doped samples. For the composite with 5 % Na-X zeolites refractive index increases with the duration of milling, while a minimum is observed for the 1 % doped composite when Na-X zeolites milled for 120 s are used as dopants.
3. After 60 s wet milling the initial size of the zeolites decreases from 983 nm to 617 nm. Additional 60 seconds of milling leads to slight increase of zeolites size from 617 nm to 729 nm. The longest milling with duration of 540 s does not influence substantially the particles size, but changes significantly their size distribution. Prolonged milling of zeolite for 540 s leads to destruction of crystallites and probable recrystallization of the zeolite phase.
4. Enhancement of the sensitivity toward acetone along with achieving good optical quality of the composite films are realized via wet-milling of the zeolites powder for 60, 120 and 540 seconds prior to film deposition. It is demonstrated that the milling time influences particle size, films' morphology, optical and sensing properties of the composite thin films.
5. The greatest reflectance change of 1.6% after exposure to acetone is obtained for films doped with zeolites milled for 120 s, and the smallest for 540 s.
6. This result clearly indicates the selectivity of $\text{Nb}_2\text{O}_5/\text{Na-X}$ composite thin films toward acetone. In the case of vapor sensing, an optimal milling time of 120 s is obtained.

THANK YOU!



Acknowledgements:

Research equipment of Distributed Research Infrastructure INFRAMAT, part of Bulgarian National Roadmap for Research Infrastructures, supported by Bulgarian Ministry of Education and Science was used in this investigation.