

# Implementation and Advantages of DFT-Based Digital Eddy Current Testing Instrument <sup>†</sup>

Songhua Huang <sup>12\*</sup>, Maocheng Hong <sup>3</sup>, Ge Lin <sup>12</sup>, Bo Tang <sup>1</sup> and Shaobin Shen <sup>1</sup>

<sup>1</sup> CGN Inspection Technology Co., Ltd., 191 Yangpu Road, Suzhou 215012, China

<sup>2</sup> National Engineering Research Center for Nuclear Power Plant Safety & Reliability, Suzhou 215012, China

<sup>3</sup> School of Electronic Science & Engineering, Southeast University, No.2 Sipailou, Nanjing 211189, China

\* Correspondence: huangsonghua\_2008@126.com

<sup>†</sup> Presented at the 10th International Electronic Conference on Sensors and Applications, 15–30 Nov 2023;

Available online: <https://ecsa-10.sciforum.net/>.

**Abstract:** Eddy current testing instrument is the core equipment for NDT (non-destructive testing) in nuclear power plants, its performance is of great significance to ensure the safety of nuclear power units throughout their life cycle. At present, mainstream eddy current instruments use analog circuits for signal processing, which structure is complex, and there are shortcomings such as large noise and weak anti-interference ability. To improve the performance of eddy current instruments, this paper creatively proposes a digital signal processing method. In this method, ARM+FPGA is used as the core of signal processing, and DFT digital signal processing algorithm is used instead of traditional hardware detection circuits to complete the processing of eddy current signals. The parallel DFT operation is realized in the algorithm, and up to 10 superimposed signals of different frequencies can be operated simultaneously, which further improves the detection efficiency of the instrument. The measured results show that the digital instrument designed in this paper greatly simplifies the hardware circuit, reduces the overall electronic noise level, and improves the signal-to-noise ratio and detection efficiency. The instrument supports BOBBIN, MRPC and ARRAY detection technologies, which fully meets the application needs of NDT in nuclear power plants.

**Keywords:** eddy current instrument; DFT (Discrete Fourier transform); nuclear power plants; signal processing

## 1. Introduction

Eddy current testing technology is a NDT (non-destructive testing) method based on the principle of electromagnetic induction[1]. If the defect in conductor interferes with the trajectory of the eddy currents, the equilibrium state will be changed, and the defect information can be obtained by detecting the change of the eddy current magnetic field[2]. Figure 1a shows the trajectory of eddy currents in a defect-free conductor when the excitation coil is applied. Figure 1b depicts the changes when there is a crack in the conductor.

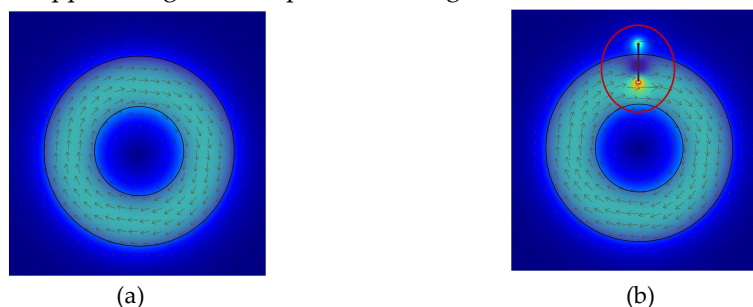

**Figure 1.** (a) Distribution of eddy currents when there are no defects in the conductor, (b) Distribution of eddy currents when there is a crack in the conductor.

**Citation:** To be added by editorial staff during production.

Academic Editor: Firstname Last-name

Published: date



**Copyright:** © 2023 by the authors. Submitted for possible open access publication under the terms and conditions of the Creative Commons Attribution (CC BY) license (<https://creativecommons.org/licenses/by/4.0/>).

Eddy current testing is essentially a magnetic field disturbance problem that can be calculated using the Maxwell equation. When the excitation signal changes in time harmonics, its mathematical model can be regarded as a derivation issue from the beginning of time-harmonic electromagnetic field to disturbance electromagnetic field generated by defect. Taking the harmonic factor  $e^{j\omega t}$ ,  $\omega > 0$ , the Maxwell equation can be written as equation(1) [3].

$$\begin{cases} \nabla * H = J_s + (\sigma + j\omega\epsilon)E \\ \nabla * E = -j\omega B \\ \nabla * B = 0 \\ \nabla * D = \rho \end{cases} \quad (1)$$

Where H is the magnetic field strength,  $J_s$  is the current density of the conductor surface, D is the electric displacement, B is the magnetic induction, E is the electric field intensity, and  $\rho$  is the bulk density of free charge. The solution of this equation is complex and not suitable for engineering applications.

Further research shows that changes in various factors of conductors will cause changes in impedance of the detection coil[1]. Eddy current detection can be abstracted into monitoring impedance value of the sensing coil with the following functional formula:

$$Z = F(\rho, \mu, x, f, r, h) \quad (2)$$

Where Z represents the detection coil impedance,  $\rho$  represents the conductivity,  $\mu$  represents the magnetic permeability,  $x$  represents the material defect,  $f$  represents the excitation coil frequency,  $r$  represents the probe radius, and h represents the distance between the test piece and the probe. In engineering applications,  $\rho$ ,  $\mu$ ,  $f$ ,  $r$ , and h are kept unchanged so that the correspondence between the sensor coil impedance Z and the material defect x can be established. This makes eddy current testing easier to implement.

To facilitate defect analysis, changes in coil impedance are usually converted into changes in the real and imaginary parts of the signal[1]. Figure 2(b) is an impedance plane plot showing the trajectory of the impedance change of the test coil. Strip charts are formed on the basis of impedance plane diagram. Figure 2a shows the strip chart in horizontal direction, representing the real part signal of the test coil, Figure 2c shows in vertical direction, representing the imaginary part signal of the coil.

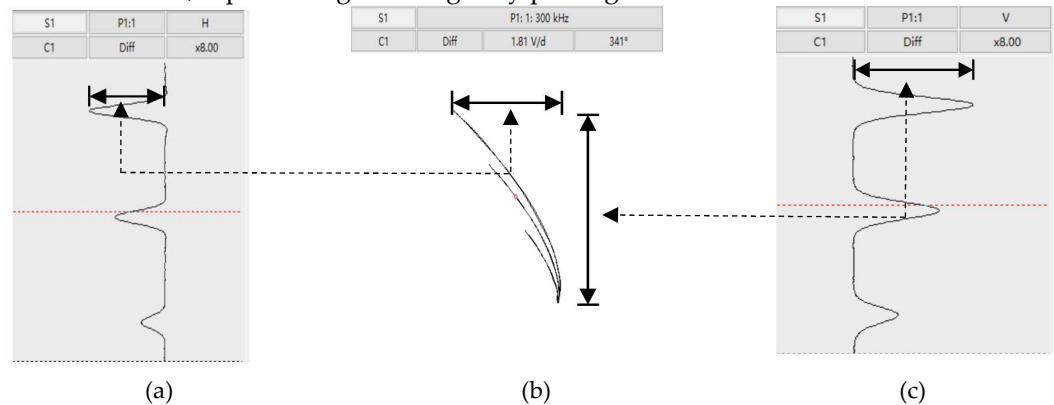

**Figure 2.** (a)Strip chart in horizontal direction, showing changes in real part of coil impedance; (b) Impedance plan, characterizing the trajectory of coil impedance changes; (c)Strip chart in vertical direction, showing changes in the imaginary part of coil impedance.

## 2. Implementation of Digital Eddy Current Testing Instrument

The eddy current instrument designed in this paper is mainly used for NDT of core components in nuclear power plants. To eliminate the influence of strong interference signals generated by adjacent support plates, multi-frequency eddy current inspection technology is required[4]. Multi-frequency eddy current testing refers to technology that can be inspected at two or more operating frequencies simultaneously. The mixing channel superimposes the response signals of different frequencies to eliminate the

response signal of the support plate and extract the defect signal. In the eddy current test of the heat transfer tube of the steam generator, 5 frequencies are generally used at the same time[4]. This section focuses on how to implement a digital multi-frequency eddy current instrument.

Figure 3 is the schematic diagram of the digital eddy current signal processing method, the main functions of which are implemented by ARM+FPGA. ARM is used for interaction with the host computer, receiving configuration information, and uploading detection data. FPGA is mainly used to control the generation of excitation signals and the extraction of detection signals.

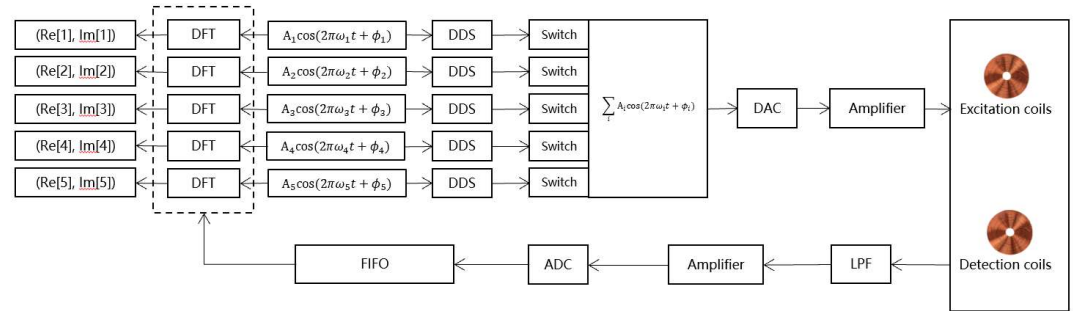

Figure 3. Digital eddy current signal processing.

The specific implementation process is described as follows:

1. Digitization of excitation signals

Depending on the characteristics of the object to be inspected, different combinations of frequencies are set. Figure 3 shows the flow when configuring five different frequencies.

Each frequency can be individually configured for its frequency, phase, and amplitude. The sinusoidal signals of different frequencies are converted into digital sine waves through DDS (Direct Digital Frequency Synthesis) technology. DDS is based on sampling theory, sampling the signal waveform at very small phase intervals, and calculating the amplitude corresponding to the phase to form a phase-amplitude table for generating the desired waveform[5]. The resulting excitation signal has the advantages of high resolution and fast conversion speed, and its stability and accuracy are improved to the same level as the reference frequency, and fine frequency adjustment can be performed over a wide range.

As shown in Figure 4(a), the excitation signal of an eddy current instrument usually uses continuous sine waves, which is easy to implement. In the application, a continuous signal of a specific length is intercepted according to the set eddy current signal sampling rate ( $f_s$ ) for subsequent calculations, the specific length is called timeslot (T). It is easy to get  $T=1/f_s$ . It is difficult for T to be exactly an integer multiple of the excitation signal period, resulting in inconsistency in each intercepted signal, affecting the detection results.

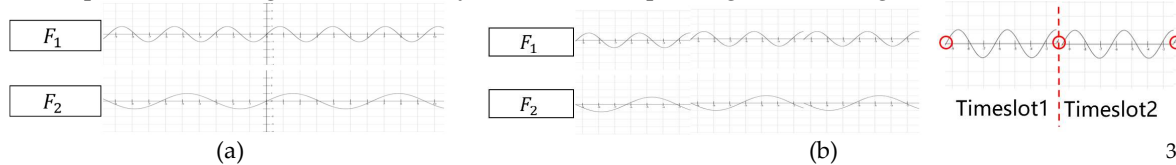

Figure 4. (a) Continuous sinusoidal signals, (b) Repeated sinusoidal excitation signals.

As shown in Figure 4(b), in this article, DDS is used to generate stable repetitive signals to ensure that the excitation signal is the same in each timeslot, so that the ADC sampling values are identical under the same defects. Enhance the repeatability of the instrument's response to the same defect.

2. Excitation signal and detection signal processing

The digitized sinusoidal signals are superimposed by calculation  $\sum_i A_i \cos(2\pi\omega_i t + \phi_i)$ , it should be noted that when superimposing, the phase of different frequencies needs

to be adjusted to avoid signal peaks superimposed together and cause amplitude overrange.

Then, the digital signal is converted to analog by DAC, where the signal has no drive capability and needs to be amplified by a power amplifier to drive the excitation probe.

The induced signal generated on the detection coil contains a lot of high-frequency noise that needs to be filtered out by a low-pass filter. The amplitude of the detection signal is generally only a few millivolts, which is prone to attenuation, and when attenuated to a certain extent, it will become an invalid signal. Therefore, in this method, adds an amplifier to the detection circuit to further improve the signal quality and anti-interference ability.

### 3. DFT (Discrete Fourier Transform)

Using DFT to complete signal parsing is core of this method, which is detailed below.

The amplified detection signal is converted into digital signal after AD conversion. The digital signal is a multi-frequency superimposed signal, which contains the defect information of the inspected object, and the real and imaginary parts corresponding to each frequency signal need to be calculated to complete the signal analysis. The analytical method adopted in this paper is to make DFT of the multi-frequency detection digital signal at the set frequency point, through which the signal is transformed from time domain to frequency domain, the spectral structure of each different frequency signal is separated, and the real and imaginary parts of each frequency signal are calculated at the same time.

The detection signal obtained by the ADC conversion is a discrete time-domain signal, based on the principle of signal processing, it can be expressed in form of equation(3).

$$x[i] = \sum_{k=0}^{N/2} ReX[k] \cos(2\pi ki/N) + \sum_{k=0}^{N/2} ImX[k] \sin(2\pi ki/N) \quad (3)$$

The DFT is calculated using the correlation-based method, and formulas are as follows[6]:

$$ReX[k] = \sum_{i=0}^{N-1} x[i] \cos(2\pi ki/N) \quad (4)$$

$$ImX[k] = -\sum_{i=0}^{N-1} x[i] \sin(2\pi ki/N) \quad (5)$$

From equations (4) and (5), it can be seen that the DFT transformation can extract the real and imaginary parts corresponding to different frequency signals in the detection signal, and  $(ReX[k], ImX[k])$  can be obtained, so as to complete the analysis of the detection signal.

Improper use of the DFT method will lead to spectrum leakage, that is, the spectral lines in the signal spectrum affect each other, so that the measurement results deviate from the actual value, and some false spectra with smaller amplitudes will appear at other frequency points on both sides of the spectral line[7]. From the perspective of time domain, DFT treats signals as infinitely long periodic signals when processing them, therefore, the signal needs to be extended processing, and the non-periodic signal should also be extended into a periodic signal. During splicing, if the repeated fragments can be spliced exactly to be consistent with the original signal, it is called perfect stitching. If not, there will be sudden changes at the splicing point, resulting in the generation of other frequency components, and the surrounding frequencies will bisect the frequencies in the original signal, resulting in inaccurate frequency amplitude and spectral leakage[8,9].

In order to avoid spectrum leakage, this method conducted in-depth research on DFT algorithm and found that when the relationship of equation (6) is strictly satisfied, there will be no spectrum leakage at all, where  $M$  is the number of periods in time domain,  $N$  is the number of sampling points, and  $F_s$  is the sampling frequency,  $F_{in}$  is the signal frequency.

$$M/N = F_{in}/F_s \quad (6)$$

Because when the above relationship is satisfied, the repeated periodic signal can be spliced exactly to coincide with the original signal, thus avoiding spectral leakage. Figure (a) is the impedance plane when spectral leakage occurs, and figure (b) is the impedance plane when the relationship (6) is satisfied.



**Figure 5.** (a) Impedance plane plot when spectral leakage occurs, (b) Normal impedance plane.

Then, the parsed ( $ReX[k]$ ,  $ImX[k]$ ) values are transmitted to host computer for professional analysts to complete the analysis and evaluation of eddy current detection results.

### 3. Advantages of digital eddy current instrument

Compared with the eddy current instrument using analog circuits for signal processing, the digital instrument designed in this paper mainly has the following advantages:

#### 1. Higher detection efficiency

Due to the limitations of the implementation mechanism, the analog eddy current instrument uses hardware multiplier to extract the detection signals. The hardware detection circuit needs to complete the extraction of different frequency signals in order, which is inefficient and can only set up to 5 different detection frequencies simultaneously.

The digital eddy current meter can use the computing power of the FPGA to extract the real and imaginary parts of different frequency signals in parallel, which greatly improves the detection efficiency, and this method can support up to 10 signals of different frequencies at the same time, expanding the application scenarios of the instrument[10].

#### 2. Higher signal-to-noise ratio

It can be seen from the principle of DFT that when doing N-point DFT operation on the signal of a certain frequency, because the signal is superimposed in phase, sampling N times will increase the amplitude in the frequency domain by N times, and the signal power will increase by  $N^2$  times. There is white noise in the detection signal, the DFT operation of noise is non-in-phase superposition, and the amplitude of the noise signal increases by  $\sqrt{N}$  times in the frequency domain, and the noise power increases N times. Therefore, the signal-to-noise ratio (signal power divided by noise power) of the digital instrument increases N times.

Analog instruments, on the other hand, extract effective signals through hardware circuits without improving the signal-to-noise ratio. When the noise floor is large, there is a risk that the measured signal will be drowned out by strong noise in engineering applications.

Therefore, the digital instrument designed in this paper has a higher signal-to-noise ratio.

#### 3. Greater dynamic range

Figure 6(a) shows the circuit block diagram of an analog eddy current instrument, which has complex circuit structure. Digital instrument, on the other hand, uses high-performance 24-bit ADC with a signal-to-noise ratio of up to 100dB, enabling a large dynamic range in the digital domain and greatly improving the ability to acquire tiny induced signals. In addition, the multi-stage amplification circuit and program-controlled circuit at the front end of the analog circuit are simplified, the influence of the analog circuit on the induced signal is reduced, and the performance of the eddy current meter is improved.

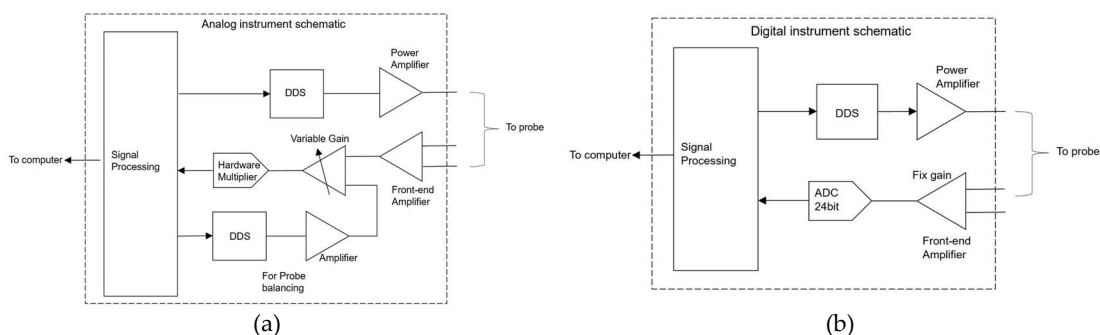

Figure 6. (a) Circuit diagram of analog instrument, (b) Circuit diagram of digital instrument.

#### 4. Application testing and conclusion

##### 4.1. Application testing

The eddy current instruments designed in this paper have been successfully applied to non-destructive testing of nuclear power plants with excellent test results. Wear damage in heat transfer tubes in nuclear power plants is often difficult to measure, Figure 7 shows the results obtained by testing the wear damage of the same heat transfer tube separately using the digital eddy current instrument designed in this article and the traditional analog instrument. It can be seen that the digital instrument has a higher signal-to-noise ratio, and the result is much clearer, which is conducive to analysis.

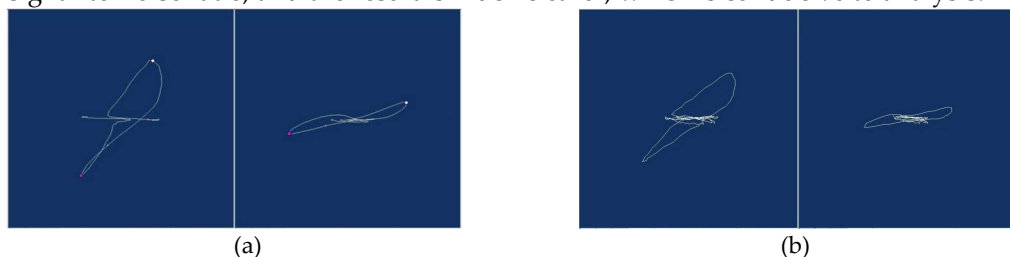

Figure 7. (a) Test result of digital instrument, (b) Test result of analog instrument.

To better present the results, 3D imaging techniques were used in this design. Figure 8 shows the 3D imaging obtained when performing a heat transfer tube eddy current inspection using an array probe. This allows the location and size of the various injuries in the tube to be clearly seen, so that the analysis can be completed more accurately.

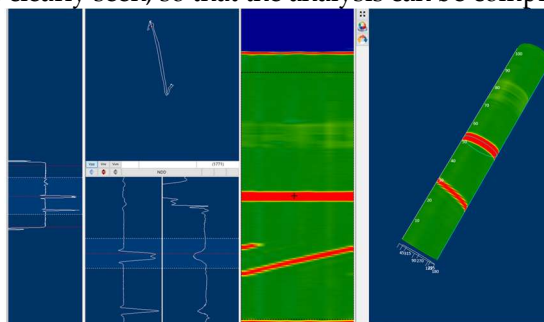

Figure 8. Array probe 3D test results.

##### 4.2. Conclusion

Through scientific research on eddy current detection, this paper creatively puts forward the design scheme of digital eddy current instrument, solves a series of problems such as architecture design, signal-to-noise ratio improvement, anti-electromagnetic interference, high-speed data processing and three-dimensional data imaging of digital eddy current instrument, and finally realizes the successful research and development of high-end eddy current instrument. The research and development results mentioned in this paper have been successfully applied to eddy current testing in many nuclear power plants, providing a guarantee for the safe and stable operation of nuclear power plants.

**Author Contributions:** Conceptualization, S.H. and G.L.; methodology, S.H. and M.H.; software, B.T. and S.H. ; validation, S.S., M.H. and G.L.; formal analysis, M.H. and B.T.; investigation, S.H. and G.L.; data curation, B.T.; writing—original draft preparation, S.H.; writing—review and editing, M.H.; visualization, B.T.; supervision, G.L.; project administration, S.H.; funding acquisition, G.L. All authors have read and agreed to the published version of the manuscript.

**Funding:** This research received no external funding.

**Institutional Review Board Statement:** Not applicable.

**Informed Consent Statement:** Not applicable.

**Data Availability Statement:** The data and intellectual property rights belong to CGN Inspection Technology Co., Ltd., ;Any sharing needs to be evaluated and approved by the company.

**Conflicts of Interest:** The authors declare no conflict of interest.

## References

1. Kebei, X.; Junhua, Z. *Eddy Current Testing*, 1st ed.; China Machine Press: Beijing, China, 2004; pp. 21–44.
2. Xie, S.; Yamamoto, T. Pulsed ECT method for evaluation of pipe wall-thinning of nuclear power plants using magnetic sensor[J]. *Studies in Applied Electromagnetics and Mechanics* **2011**, *35*, pp.203-210.
3. Li, X.; Yinzhao, L. Uniqueness and stability of solution to the linear transient eddy current electromagnetic field problem for determining solution. *ACTA PHYSICA SINICA* **2006**, *55(9)*, pp. 4397-4406.
4. Department of Defense, United States of America: MIL-STD-2023(SH) Eddy Current Inspection of Heat Exchanger Tubing on Ships of the United States Navy,1990.
5. Junzhe, G.; Feilu, L. Modular Multi-Frequency Eddy Current Test System Design Based on DDS Technology. *INSTRUMENT TECHNIQUE AND SENSOR* **2009**, *10*, pp.104-107.
6. Junzhe, G.; Mengchun, P. Research on signal processing method of multi-frequency eddy current testing based on spectrum analysis. *JOURNAL OF ELECTRONIC MEASUREMENT AND INSTRUMENT* **2011**, *25(1)*, pp.16-22.
7. Lei, C.; Qingsheng, Z. Real-time Frequency and Amplitude Measurement Algorithm Based on Improved Discrete Fourier Transformation. *Science Technology and Engineering* **2018**, *18(3)*, pp.240-245.
8. Tao, J.; Yiyang, C. Research on Synchronous Phasor Measurement Algorithm of Power System Based on Improved DFT. *Transactions of China Electrotechnical Society* **2017**, *32(17)*, pp. 1-10.
9. Tanaka, M.; Tsuboi, H. Transient eddy current analysis by the boundary element method using fourier transforms[J]. *IEEE Transactions on Magnetics* **1993**, *29*, pp.1722-1725.
10. Tong, H.; Xing, C. High-precision frequency detection with APFFT based on FPGA. *Electronic Measurement Technology* **2013**, *36(8)*, pp. 80-88.