

Numerical investigation of crack mitigation in tubular KT-joints using composite reinforcement [†]

Mohsin Iqbal ^{1,*}, Saravanan Karuppanan ¹, Veeradasan Perumal ¹, Mark Ovinis ² and Adnan Rasul ¹

¹ Mechanical Engineering Department, Universiti Teknologi PETRONAS, Seri Iskandar 32610, Malaysia; saravanan_karuppanan@utp.edu.my (S.K.), veeradasan.perumal@utp.edu.my (V.P.), adnan_22006634@utp.edu.my (A.R.)

² School of Engineering and the Built Environment, Birmingham City University, Birmingham, UK; mark.ovinis@bcu.ac.uk

* Correspondence: mohsin_22005143@utp.edu.my, engineer mohsiniqbal@gmail.com; Tel.: +60-11-6509-8596

[†] Presented at the 4th International Electronic Conference on Applied Sciences, 27 October–10 November 2023, Available online: <https://asec2023.sciforum.net/>.

Abstract: Recently, fiber reinforced polymers (FRP) have been used for steel structure reinforcement, following decades of successful utilization for the reinforcement of concrete structures. However, rehabilitation of tubular joints with a crack at the interface of mating members using FRP has rarely been investigated. A tubular KT-joint having a semi-elliptical crack subjected to axial tensile load is explored in this study. The joint was simulated using the fracture tool of ANSYS Structural, and the effect of crack size, location, and FRP reinforcement on stress intensity factor (SIF) was evaluated. The numerical simulations show that FRP reinforcement reduces the (SIF), decreases the likelihood of crack growth, and may increase the fatigue life. A 4–12 % reduction per millimeter thickness of unidirectional FRP was recorded.

Keywords: Crack mitigation; Crack growth; Composite reinforcement; Fracture analysis; Tubular joint.

1. Introduction

Offshore structures are subjected to various environmental and service loads, in addition to aging and corrosion. Possible defects can occur anywhere, including the joining point of tubular members, reducing the load-bearing capability of the entire system, with the weld line of the tubular joints being the most critical portion of an offshore structure, prone to crack initiation and rapid growth. Routine inspection identifies such deteriorations and evaluates their effect and possible remedies [1]. Various rehabilitation techniques can be adopted to recover or enhance the load capacity of tubular joints [2]. Replacement or repair of these cracks is vital for safe operation. However, replacement may be costly and practically impossible, with repair being the only viable option. Traditionally, repair was accomplished by welding or clamping extra plates to reinforce damaged areas. Hot work such as cutting and welding are required to replace the corroded structures or add extra thickness, which increases the risk of disasters [3]. Techniques utilizing cold work are preferred for restoring oil and gas structures. Among these, fiber reinforcement of a defective joint has many competitive advantages [2].

Fiber reinforced polymers (FRP) have been used for the reinforcement of steel structures after decades of successful utilization for civil structures [4–6]. ASME PCC-2 [7] and ISO 24817 [8] cover the repair of pipelines using FRP as a legitimate repair technique. It can be applied without hot work (ambient temperature curing). Even structures under the water can be reinforced, as various specialized epoxies can cure in the aqueous environment. FRP reinforcement of joints does not need load isolation; hence, shutdown of

Citation: To be added by editorial staff during production.

Academic Editor: Firstname Last-name

Published: date



Copyright: © 2023 by the authors. Submitted for possible open access publication under the terms and conditions of the Creative Commons Attribution (CC BY) license (<https://creativecommons.org/licenses/by/4.0/>).

the platform is not required. Reinforcement layout can be customized for specific strength and stiffness requirements at different joints, locations, and directions, and minimal repair materials suffice for various geometric shapes and load requirements [2]. Various researchers have investigated FRP reinforcement of tubular joints in recent years, numerically and experimentally [9–15]. However, these studies focus on enhancing load capacity and fatigue life enhancement using FRP reinforcement. Most of these studies are on the reduction of stress concentration factor due to FRP, which can be used to determine the increase in fatigue life. Besides enhancing the load capacity, FRP reinforcement can mitigate crack propagation when a joint crack has been identified. Until now, the effect of FRP reinforcement on tubular joints with cracks at the interface has never been reported in open literature.

The stress intensity factor (SIF) is an important parameter for the failure assessment of cracked structures. It can predict crack initiation and propagation. Stresses at the crack tip are proportional to SIF. The crack will grow further if the SIF exceeds the material's fracture toughness (FT) limit. But if the SIF is lower than FT, the crack will not propagate. Various two and three-dimensional fatigue crack problems have been investigated, and more than 600 formulas have been used for calculating SIF for different crack base geometries, cracks, and loading conditions [16–25]. Depending on the load, the crack can be mode I, II, or III. Practical structures are subjected to various loads simultaneously, including tension, shear, and torsion, resulting in a mixed crack mode [26]. The Fracture tool of ANSYS gives SIF for all three modes. The maximum of these shows the dominant mode of crack propagation. This paper investigates a cracked KT-joint using the fracture tool of ANSYS. The effect of crack size, crack location, and FRP reinforcement on SIF is evaluated.

2. Methodology

A typical KT-joint based on the dimensions of Ahmadi et al. [27] was modeled, as shown in **Figure 1**. A semi-elliptical crack was assumed at the weld line of the central brace-chord interface of a typical KT-joint. After sensitivity analysis, the model was meshed using 7,91,644 tetrahedral elements. An arbitrary crack was incorporated using the built-in fracture tool of ANSYS. The numerical model was simulated using the static structural module of ANSYS Workbench 21 R1. The ends of the chord and inclined braces were constrained in all degrees of freedom (fixed constraints), as shown in **Figure 2**. An axial tensile load of 30 MPa was applied on the central brace. Static structural analysis was performed using an HP Zbook Core i7-1185G7 workstation with 16 GB RAM. SIF was computed for all three modes of cracks, but only K1 was significant, as tensile loading was causing mode-I to be dominant.

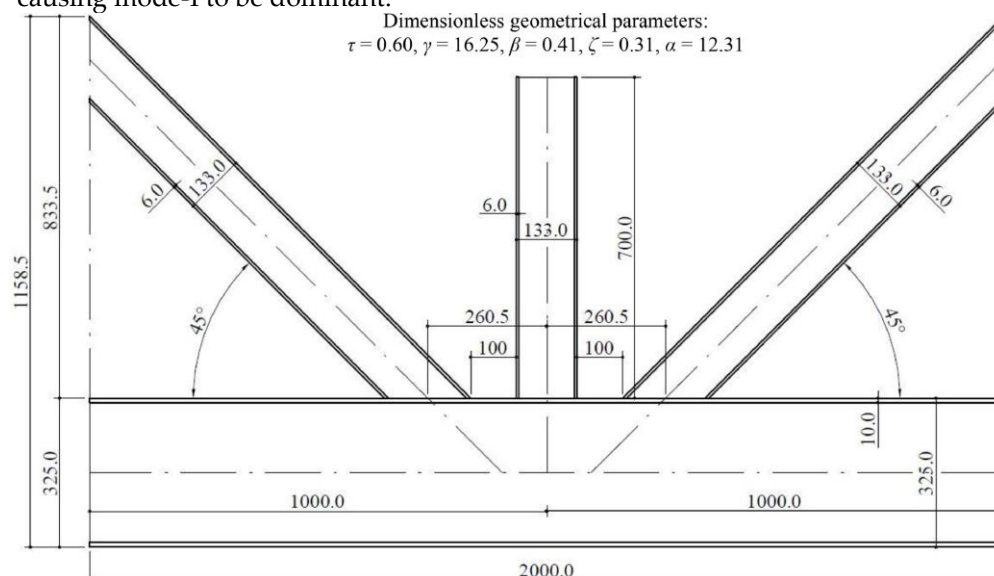

Figure 1. Geometry of the KT-joint used for simulations [27].

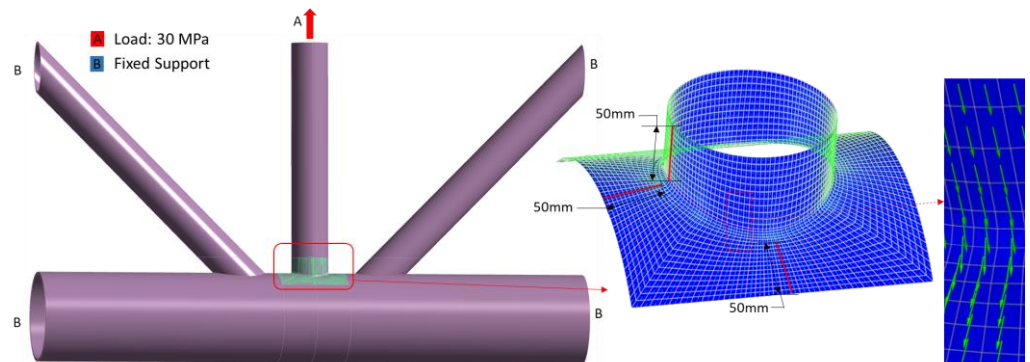

Figure 2. KT-joint with a crack at the chord and central brace interface, reinforced with CFRP UD.

The effect of crack location was investigated by simulating cracks of the same dimension at different locations around the brace axis, namely the saddle, crown, and an arbitrary position in-between the saddle and crown, as shown **Figure 3**. A 1/4th model was assessed as a 1/4th symmetry can be assumed for a KT-joint with an axial tensile load on the central brace [28]. The effect of cracks at other positions can be approximated from these three positions. The interface region of the joint having the crack was reinforced with unidirectional Carbon FRP (CFRP), with a lamina thickness of 0.2mm. The mechanical properties of CFRP are listed in **Table 1** [29]. A minimum overlap of 50mm was assumed to be sufficient around the chord-central brace interface.

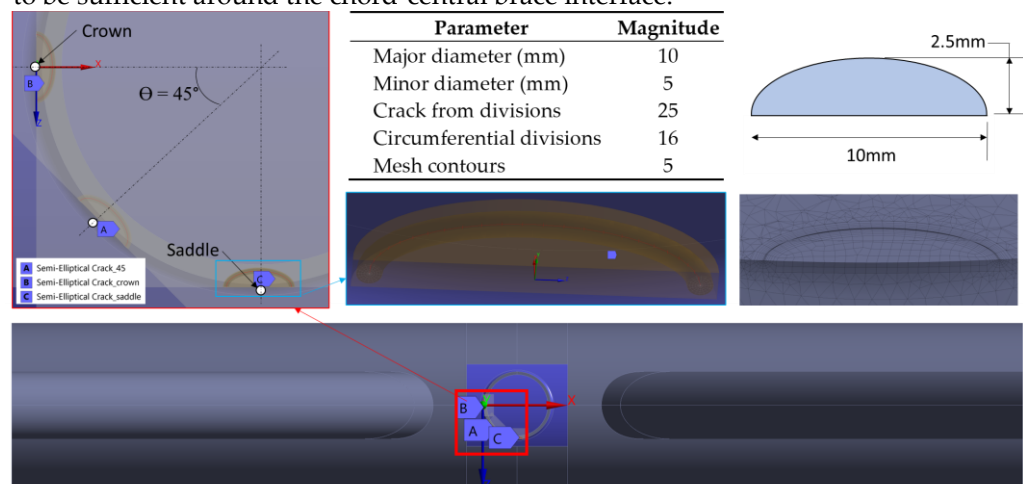

Figure 3. KT-joint with semi-elliptical crack.

Table 1. Parameters of Semi-elliptical crack. [29]

	Parameter	Magnitude
CFRP UD	Young modulus, E_x (GPa)	134
	Young modulus, E_y (GPa)	10.3
	Young modulus, E_z (GPa)	10.3
	Shear modulus, G_{xy} (GPa)	5.5
	Shear modulus, G_{yz} (GPa)	5.5
	Shear modulus, G_{xz} (GPa)	3.2
	Poisson's ratio, ν_{xy}	0.33
	Poisson's ratio, ν_{yz}	0.53
	Poisson's ratio, ν_{xz}	0.33
Steel pipe	Young modulus, E (GPa)	211

Poisson's ratio, ν	0.3
------------------------	-----

The effect of reinforcement thickness could be investigated either through variation in the number of layers for a given lamina thickness or selecting a fixed number of layers and varying the lamina thickness, with the lamina thickness depending on the thickness of the dry fabric, the layup process, and the curing method. Once the base material and fabrication process are selected, the number of layers and their orientation are varied for optimum response. The lamina thickness was fixed in the current study, while the effect of the number of layers was investigated. Different reinforcement layers were applied to the crack region, and the corresponding SIF was determined. Reinforcement layers can be oriented in different directions, and selecting the optimum orientation is vital [30,31]. For tensile load on the central brace, the best direction of reinforcement was orthogonal to the weld toe, as shown in **Figure 2**. Hence, the optimization of orientation was not investigated in the current study.

3. Results and Discussion

The analyzed problem was mode-I dominant; hence, only results of SIF-K1 are presented. However, SIF reduction was noticed for all three modes. The numerical simulations show the effectiveness of FRP reinforcement for reducing SIF and mitigating cracks, thus decreasing the chances of crack growth and increasing fatigue life.

3.1. Effect of crack size

The physical size of the crack has an obvious effect on the SIF. A semi-elliptical crack with different major and minor diameters was simulated. The major diameter was fixed twice the minor diameter to limit the variables, and a comparison of SIF as a function of the major diameter is shown in **Figure 4**. It was found that SIF increases with an increase in crack size. A similar effect of crack size was revealed by Subbaiah and Bollineni [32], for unreinforced pressurized cylinders; and Wnag et al. [33] for rectangular plates reinforced with FRP. SIF is usually high at the crack tips and reduces along the crack front towards the center. However, SIF is higher at the center for a relatively small crack.

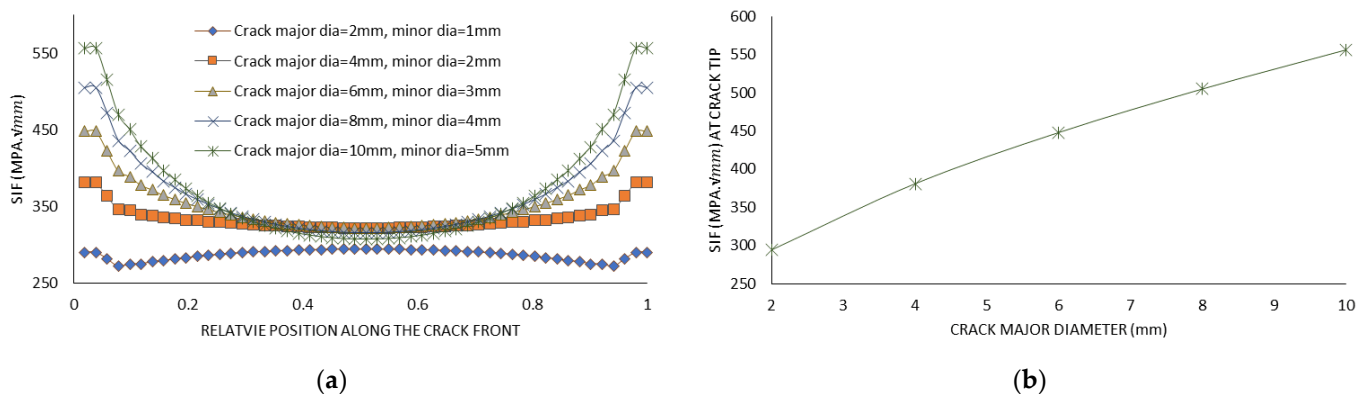

Figure 4. SIF variation with crack size (for a crack at the saddle position without reinforcement): (a) SIF along the crack front; (b) SIF at the crack tip.

3.2. Effect of crack position

The criticality of a crack depends on its location. A saddle point crack causes relatively higher SIF than other positions, as shown in **Figure 5**. This effect is due to higher stress concentration at the saddle point than at the crown when a KT-joint is subjected to axial compressive load. When a tubular joint is subjected to combined load, the location of maximum stress depends on the direction and relative magnitude of load components [34]. For such situations, knowing the crack location would be critical for assessment. A specific size crack may be ignorable at one position and fatal for the same structure at another.

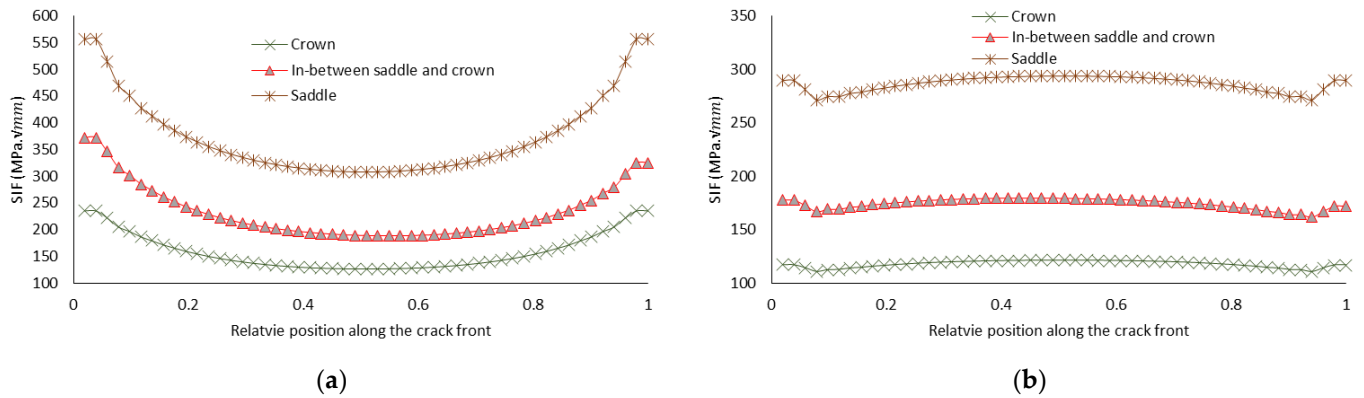

Figure 5. Effect of crack position on SIF (without reinforcement): (a) crack major diameter = 10 mm, minor diameter = 5 mm; (b) crack major diameter = 2 mm, minor diameter = 1 mm.

3.2. Effect of thickness of FRP reinforcement

It was found that the greater the number of reinforcement layers, the lower the SIF. A similar correlation of SIF with thickness of FRP reinforcement was revealed by Wang et al. [33] for rectangular plates. Hence, the number of reinforcement layers should be decided based on the reduction in SIF required, as it would impart dead weight and cost. **Figure 6** shows the reduction behavior of SIF with an increase in the number of reinforcement layers for a crack having its center at the saddle position. Similarly, **Figure 7** shows the same for a crack at the crown position. For cracks at both locations, the reduction of SIF at the crack tip was 4–12 % per millimeter of CFRP reinforcement.

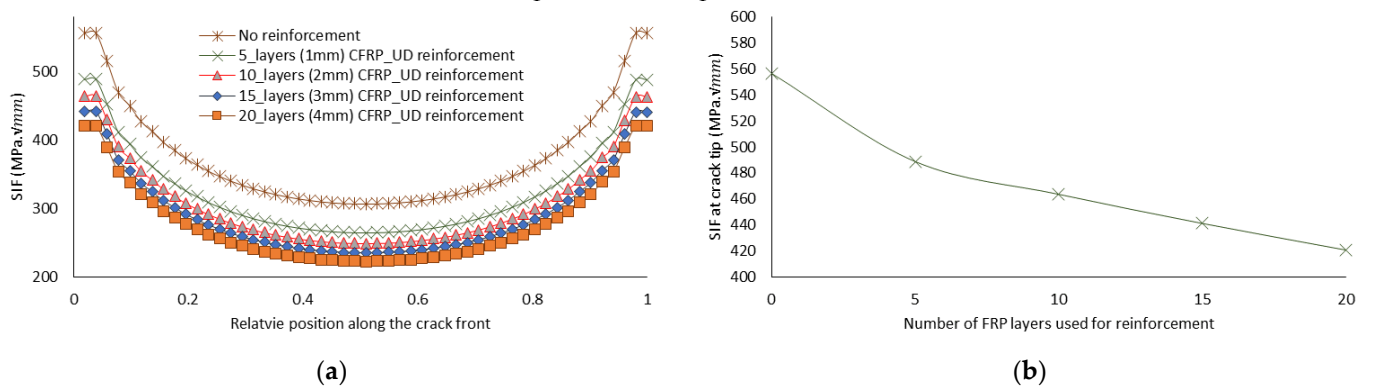

Figure 6. SIF variation due to FRP reinforcement (for a crack at saddle position, major diameter = 10 mm, minor diameter = 5 mm, reinforcement = CFRP oriented orthogonal to weld, mechanical properties [29]): (a) SIF variation along the crack; (b) SIF at the crack tip.

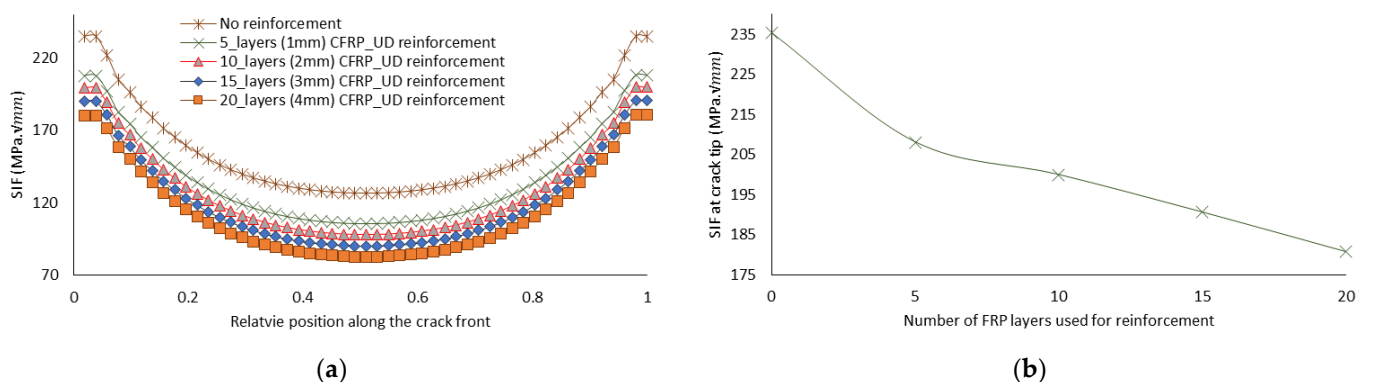

Figure 7. SIF variation due to FRP reinforcement (for a crack at crown position, major diameter = 10 mm, minor diameter = 5 mm, reinforcement = CFRP oriented orthogonal to weld, mechanical properties [29]): (a) SIF variation along the crack; (b) SIF at the crack tip.

4. Conclusion:

Crack propagation at the weld toe of a tubular KT-joint has been studied using fracture analysis. A semi-elliptical crack was introduced, and the effect of crack size, position, and fiber reinforced polymer (FRP) reinforcement on stress intensity factor (SIF) was investigated. An increase in the size of the crack was found to increase the SIF. It was revealed that the magnitude of SIF depends on the location. SIF was maximum at the point where stress was maximum. Hence, the knowledge of a joint's stress behavior is vital for assessing the criticality of a crack in joints. The simulation proved the capability of FRP reinforcement for reducing the SIF at the crack and mitigating crack propagation. Empirical modeling of the SIF in FRP-reinforced tubular joints with a crack will benefit quick assessment. Experimental verification of these findings and investigation of joints under combined loads can be carried out in the future.

Supplementary Materials: Not applicable.

Authors contribution: Conceptualization, S.K. and M.I.; analysis, M.I. and A.R.; writing—original draft preparation, M.I.; writing—review and editing, S.K, M.I., V.P., and M.O.; supervision, S.K. and V.P.; project administration, S.K.; funding acquisition, S.K. All authors have read and agreed to the published version of the manuscript.

Funding: This research received funding from Yayasan Universiti Teknologi PETRONAS under grant No. 015LC0-443.

Institutional Review Board Statement: Not applicable.

Informed Consent Statement: Not applicable.

Data Availability Statement: Not applicable.

Acknowledgments: Not applicable.

Conflicts of Interest: The authors declare no conflict of interest.

References

1. Martinez, J.L., Ramalho, J.C., Murilo, C., Irving, A.V., Victor, D.H., Perrut, V.A., and Gomes, G. (2023) CFRP - patch repair characterization for compressive capacity recovery of perforated steel tubular members. *J. Brazilian Soc. Mech. Sci. Eng.*, **4**.
2. Iqbal, M., Karuppanan, S., Perumal, V., and Ovinis, M. (2023) Rehabilitation Techniques for Offshore Tubular Joints. *J. Mar. Sci. Eng.*, **11**, 461.
3. Nichols, N.W., and Khan, R. (2017) Remediation and Repair of Offshore Structures. *Encycl. Marit. Offshore Eng.*, (April), 1–15.
4. Dehghani, A., and Aslani, F. (2019) A review on defects in steel offshore structures and developed strengthening techniques. *Structures*, **20** (July), 635–657.
5. Tafsirojjaman, T., Ur Rahman Dogar, A., Liu, Y., Manalo, A., and Thambiratnam, D.P. (2022) Performance and design of steel structures reinforced with FRP composites : A state-of-the-art review. *Eng. Fail. Anal.*, **138** (November 2021), 106371.
6. Siddika, A., Mamun, M.A. Al, Ferdous, W., and Alyousef, R. (2020) Performances, challenges and opportunities in strengthening reinforced concrete structures by using FRPs – A state-of-the-art review. *Eng. Fail. Anal.*, **111** (February), 104480.
7. American Society of Mechanical Engineers (2011) Repair of Pressure Equipment and Piping - ASME PCC-2. *Asme Pcc-2*, 1–216.
8. International Organization for Standardization (2017) Petroleum, petrochemical and natural gas industries – composite repairs of pipework – qualification and design, installation, testing and inspection - ISO 24817. *61010-1* © Iec2001.
9. Sadat Hosseini, A., Bahaari, M.R., Lesani, M., and Hajikarimi, P. (2021) Static load-bearing capacity formulation for steel

- tubular T/Y-joints strengthened with GFRP and CFRP. *Compos. Struct.*, **268** (December 2020), 113950.
10. Hosseini, A.S., Bahaari, M.R., and Lesani, M. (2020) SCF distribution in FRP-strengthened tubular T-joints under brace axial loading. *Sci. Iran.*, **27** (3 A), 1113–1129.
 11. Xu, G., Tong, L., Zhao, X.L., Zhou, H., and Xu, F. (2020) Numerical analysis and formulae for SCF reduction coefficients of CFRP-strengthened CHS gap K-joints. *Eng. Struct.*, **210** (December 2019), 110369.
 12. Nassiraei, H., and Rezadoost, P. (2020) Stress concentration factors in tubular T/Y-joints strengthened with FRP subjected to compressive load in offshore structures. *Int. J. Fatigue*, **140** (November 2019), 105719.
 13. Sadat Hosseini, A., Bahaari, M.R., and Lesani, M. (2020) Experimental and parametric studies of SCFs in FRP strengthened tubular T-joints under axially loaded brace. *Eng. Struct.*, **213** (March), 110548.
 14. Tong, L., Xu, G., Zhao, X.L., Zhou, H., and Xu, F. (2019) Experimental and theoretical studies on reducing hot spot stress on CHS gap K-joints with CFRP strengthening. *Eng. Struct.*, **201** (August), 109827.
 15. Sadat Hosseini, A., Bahaari, M.R., and Lesani, M. (2019) Stress concentration factors in FRP-strengthened offshore steel tubular T-joints under various brace loadings. *Structures*, **20** (April), 779–793.
 16. Ullah, H., Harland, A.R., and Silberschmidt, V. V. (2015) Characterisation of mechanical behaviour and damage analysis of 2D woven composites under bending. *Compos. Part B Eng.*, **75**, 156–166.
 17. Ullah, H., and Silberschmidt, V. V. (2015) Analysis of impact induced damage in composites for wind turbine blades. *2015 Power Gener. Syst. Renew. Energy Technol. PGSRET 2015*, 1–6.
 18. Ullah, H., Harland, A.R., and Silberschmidt, V. V. (2015) Dynamic bending behaviour of woven composites for sports products: Experiments and damage analysis. *Mater. Des.*, **88**, 149–156.
 19. Ahmed, M., Ullah, H., and Rauf, A. (2016) Fracture mechanics based fatigue life estimation of axial compressor blade. *Proc. 2016 13th Int. Bhurban Conf. Appl. Sci. Technol. IBCAST 2016*, 69–74.
 20. Iqbal, M., Alam, K., Ahmad, A., Maqsood, S., Ullah, H., and Ullah, B. (2022) An enriched finite element method for efficient solutions of transient heat diffusion problems with multiple heat sources. *Eng. Comput.*, **38** (4), 3381–3397.
 21. Ullah, H., Alam, K., Iqbal, M., Husain, A., and Silberschmidt, V. V. (2022) Simulation of buckling-driven progressive damage in composite wind turbine blade under extreme wind loads. *Eng. Fail. Anal.*, **140** (May), 106574.
 22. Ullah, H., and Silberschmidt, V. V. (2015) Numerical analysis of the interactive damage mechanisms in two-dimensional carbon fabric-reinforced thermoplastic composites under low velocity impacts. *J. Compos. Mater.*, **49** (25), 3127–3143.
 23. Ahmed, T., Choudhry, R.S., Ullah, H., and Hassan, F. (2015) Numerical Modelling of Carbon Fibre Reinforced Polymer Composites for Hole Size Effect. **8** (1), 1–9.
 24. Ullah, H., Harland, A.R., Lucas, T., Price, D., and Silberschmidt, V. V. (2012) Finite-element modelling of bending of CFRP laminates: Multiple delaminations. *Comput. Mater. Sci.*, **52** (1), 147–156.
 25. Ullah, H., Harland, A.R., Lucas, T., Price, D., and Silberschmidt, V. V. (2011) Analysis of nonlinear deformations and damage in CFRP textile laminates. *J. Phys. Conf. Ser.*, **305** (1).
 26. Qi, S., Cai, L.X., Bao, C., Chen, H., Shi, K.K., and Wu, H.L. (2019) Analytical theory for fatigue crack propagation rates of mixed-mode I–II cracks and its application. *Int. J. Fatigue*, **119** (July 2018), 150–159.
 27. Ahmadi, H., and Zavvar, E. (2020) Degree of bending (DoB) in offshore tubular KT-joints under the axial, in-plane bending (IPB), and out-of-plane bending (OPB) loads. *Appl. Ocean Res.*, **95** (2020), 102015.
 28. Iqbal, M., Karuppanan, S., Perumal, V., Ovinis, M., and Nouman, H. (2023) An artificial neural network model for the stress concentration factors in KT-joints subjected to axial compressive load. *Mater. Sci. Forum*.
 29. Zhang, Y., Zhang, K., Zhao, H., Xin, J., and Duan, M. (2018) Stress analysis of adhesive in a cracked steel plate repaired with CFRP. *J. Constr. Steel Res.*, **145**, 210–217.
 30. Iqbal, M., Khan, A., Iqbal, M., and Azam, K. (2013) Layup Optimization of Laminated Structures. *Int. Conf. Model. Simul. 2013*,

I (Volume I), 259–262.

31. Iqbal, M. (2013) Weight Optimization of UAV. (December 2020).
32. Subbaiah, A., and Bollineni, R. (2020) Stress Intensity Factor of Inclined Internal Edge Crack in Cylindrical Pressure Vessel. *J. Fail. Anal. Prev.*, **20** (5), 1524–1533.
33. Wang, H.T., Wu, G., and Pang, Y.Y. (2018) Theoretical and numerical study on stress intensity factors for FRP-strengthened steel plates with double-edged cracks. *Sensors (Switzerland)*, **18** (7).
34. Iqbal, M., Karuppanan, S., Perumal, V., Ovinis, M., and Nouman, H. (2023) Empirical modeling of stress concentration factors using FEA and artificial neural networks for the fatigue design of tubular KT-joints under combined loading. *Fatigue Fract. Eng. Mater. Struct.*, (August), 1–17.

Disclaimer/Publisher's Note: The statements, opinions and data contained in all publications are solely those of the individual author(s) and contributor(s) and not of MDPI and/or the editor(s). MDPI and/or the editor(s) disclaim responsibility for any injury to people or property resulting from any ideas, methods, instructions or products referred to in the content.